



Digital 280-1 digital indicator

Digital 280-1

Digital 280-1



Digital 280-1

universal line
universal line

Digital 280-1

Digital 280-1

Operating manual

English

9499-040-67311

Valid from: 8495



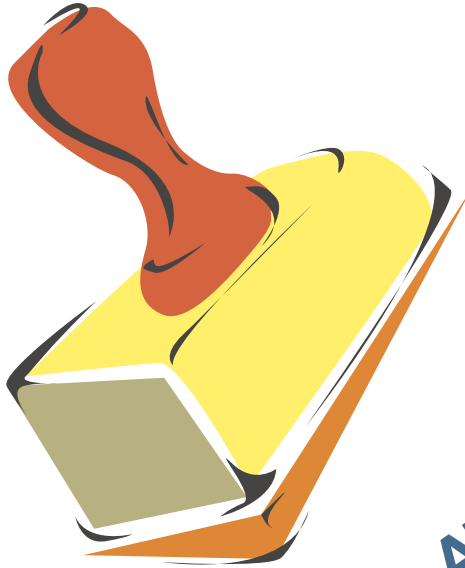

BlueControl

More efficiency in engineering,
more overview in operating:
The projecting environment for the BluePort® controllers



ATTENTION!
Mini Version and Updates on
www.pma-online.de
or on PMA-CD

Description of symbols in the text:

-  General information
-  General warning
-  Attention: ESD-sensitive devices

on the device:



-  Follow the operating instructions

© PMA Prozeß- und Maschinen-Automation GmbH • Printed in Germany
All rights reserved.

No part of this document may be reproduced or published in any form or by any means
without prior written permission from the copyright owner.

A publication of PMA Prozeß- und Maschinen Automation
P.O.Box 310229
D-34058 Kassel
Germany

Inhaltsverzeichnis

1	Mounting	5
2	Electrical connections	6
2.1	Connecting diagram.	6
2.2	Terminal connection	6
3	Operation	10
3.1	Front view	10
3.2	Behaviour after power-on	10
3.3	Operating level	11
3.3.1	Min/max function	11
3.3.2	Tare function	12
3.3.3	Sample&hold amplifier	12
3.3.4	O ₂ measurement	13
3.3.5	Extended operating level	14
3.3.6	Alarm handling	15
3.4	Maintenance manager / Error list	16
4	Controller	17
4.1	Operation	17
4.2	Control parameters.	17
4.3	Self-tuning.	18
4.3.1	Self-tuning start ( + )	18
4.3.2	Self-tuning cancellation	18
4.3.3	Acknowledgement procedures in case of unsuccessful self-tuning .	19
4.3.4	Examples for self-tuning attempts	19
4.3.5	(controller inverse, heating or heating/cooling)	19
4.4	Manual tuning	20
4.5	Operating structure	22
5	Configuration level	23
5.1	Configuration survey	23
5.2	Configuration	24
5.3	Configuration examples	30
5.3.1	On-Off controller / Signaller (inverse)	30

5.3.2	2-point controller (inverse)	31
5.3.3	Continuous controller (inverse)	32
5.3.4	Digital 280-1 with measured value output	33
6	Parameter setting level.	34
<u>6.1</u>	Parameter survey	34
<u>6.2</u>	Parameter	35
<u>6.3</u>	Input scaling	36
6.3.1	Input I_{nP}	36
7	Calibration level	37
<u>7.1</u>	Offset correction	37
8	BlueControl.	40
9	Versions.	41
10	Technical data.	42
11	Safety hints	46
<u>11.1</u>	Resetting to factory setting	47

1 Mounting

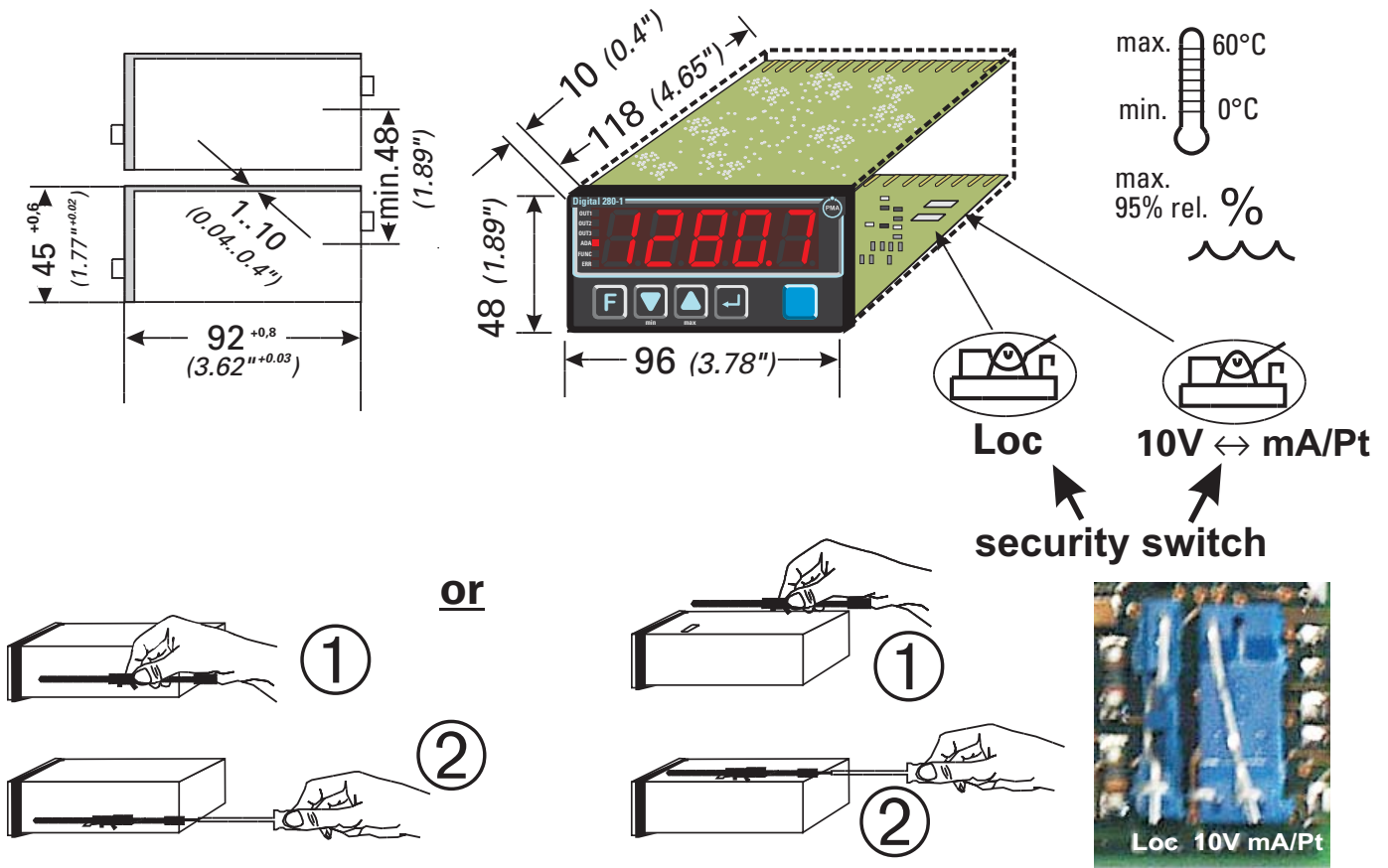

Safety switch:

For access to the safety switches, the indicator must be withdrawn from the housing. Squeeze the top and bottom of the front bezel between thumb and forefinger and pull the controller firmly from the housing..

10V i mA/Pt	right ❶	Current signal / Pt100 / thermocouple/mV at 1 nP
	left	Voltage signal (V) at 1 nP
Loc	open	Access to the levels is as adjusted by means of BlueControl (engineering tool) ❷
	closed ❶	all levels accessible without restriction

❶ Factory setting

❷ Default setting: display of all levels suppressed, password `PASS = OFF`



Safety switch 10V ↔ mA/Pt always in position left or right. Leaving the safety switch open may lead to faulty functions!



Caution! The unit contains ESD-sensitive components.

2 Electrical connections

2.1 Connecting diagram

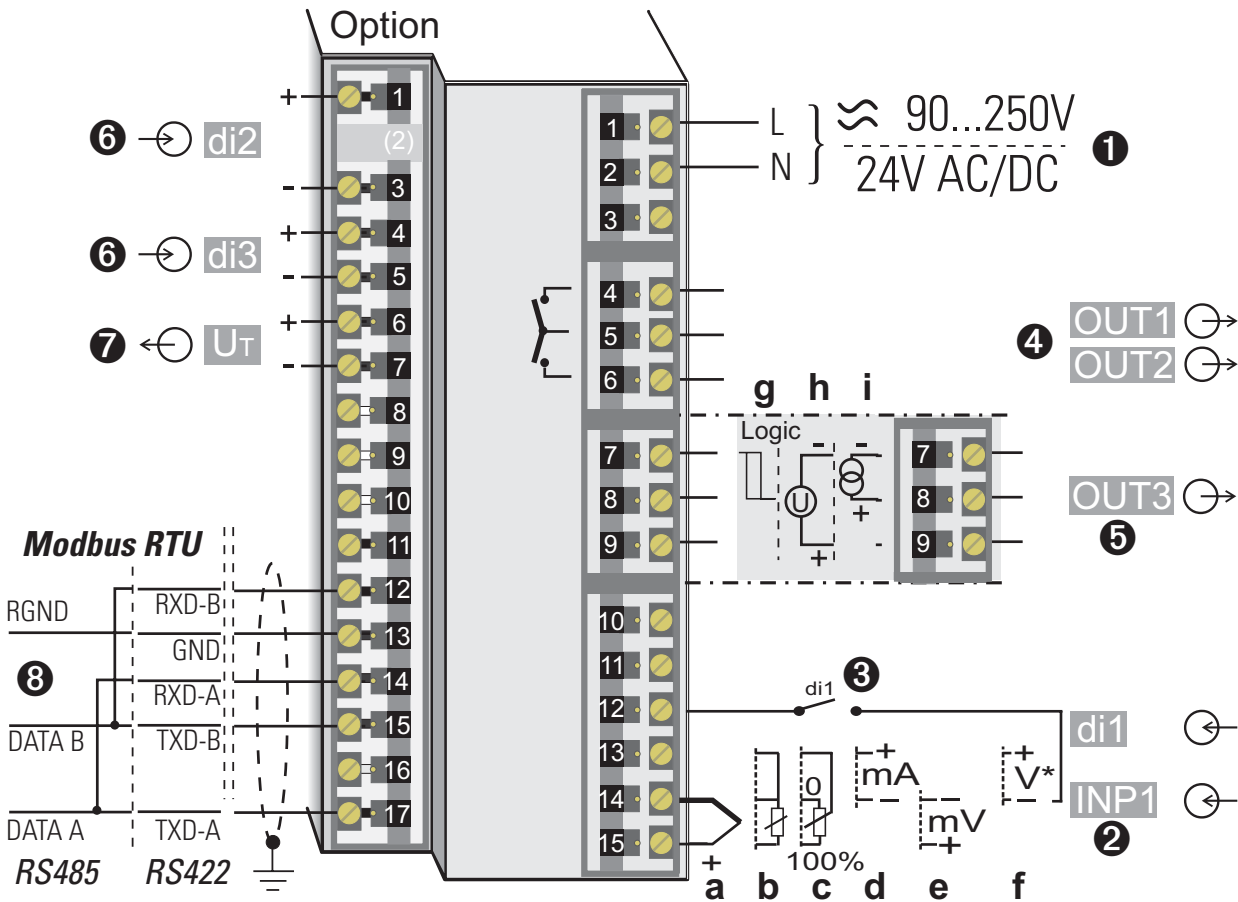

* Safety switch mA ↔ V in position left

i The indicator is provided with screw terminals from 0,5 to 2,5mm².

2.2 Terminal connection

Power supply connection ①

See chapter 10 "Technical data"

Connection of input INP1 ②

Input for variable x1 (process value)

- a thermocouple
- b resistance thermometer (Pt100/ Pt1000/ KTY/ ...)
- c potentiometer
- d current (0/4...20mA)
- e voltage (-2,5...115/-25...1150/-25...90/ -500...500mV)
- f voltage (0/2...10V/ -5...5V)

Connection of input di1 ③

Digital input, configurable as switch or push-button

Connection of outputs OUT1/2 ④

Relay outputs 250V/2A normally open with common contact connection

Connection of output OUT3 ⑤

- g** logic (0..20mA / 0..12V)
- h** voltage (0/2...10V)
- i** current (0/4...20mA)
- i** transmitter power supply

Connection of inputs di2/3 ⑥ (option)

Digital inputs (24VDC external), galvanically isolated, configurable as switch or push-button

Connection of output U_T ⑦ (option)

Supply voltage connection for external energization

Connection of bus interface ⑧ (option)

RS422/485 interface with Modbus RTU protocol

⑥ ⑦ di2/3, U_T 2-wire transmitter supply

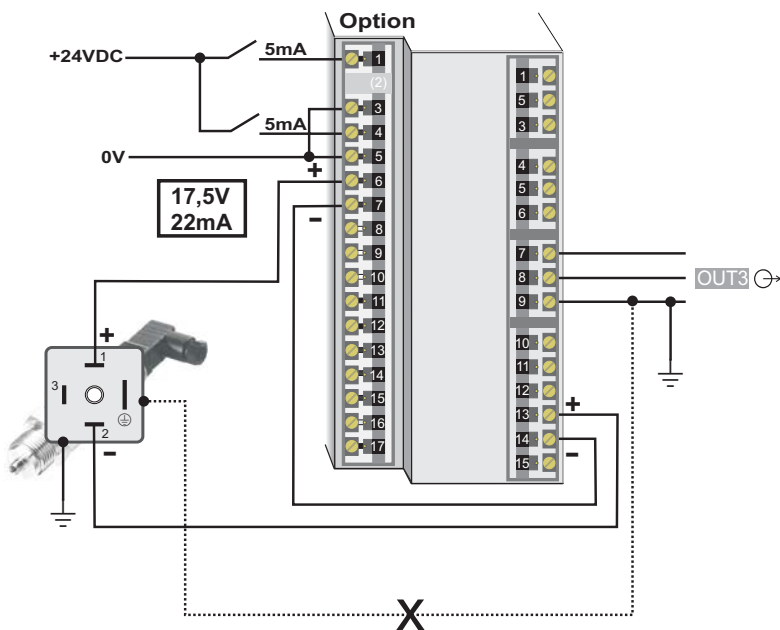

⑥ OUT3 transmitter supply

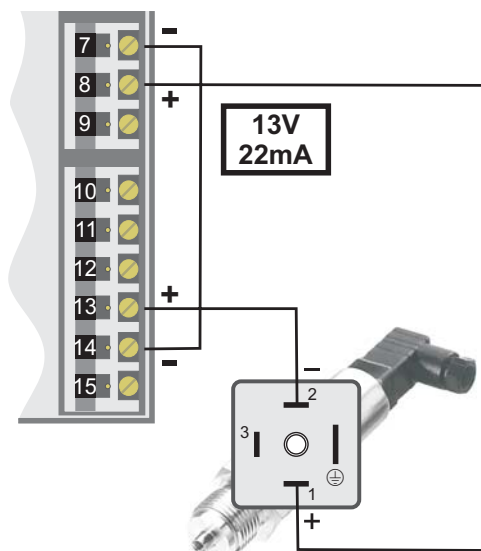

If U_T and the universal output OUT3 is used there may be no external galvanic connection between measuring and output circuits!

6 OUT 3 als Logikausgang mit Solid-State-Relais (Reihen- und Parallel-Schaltung)

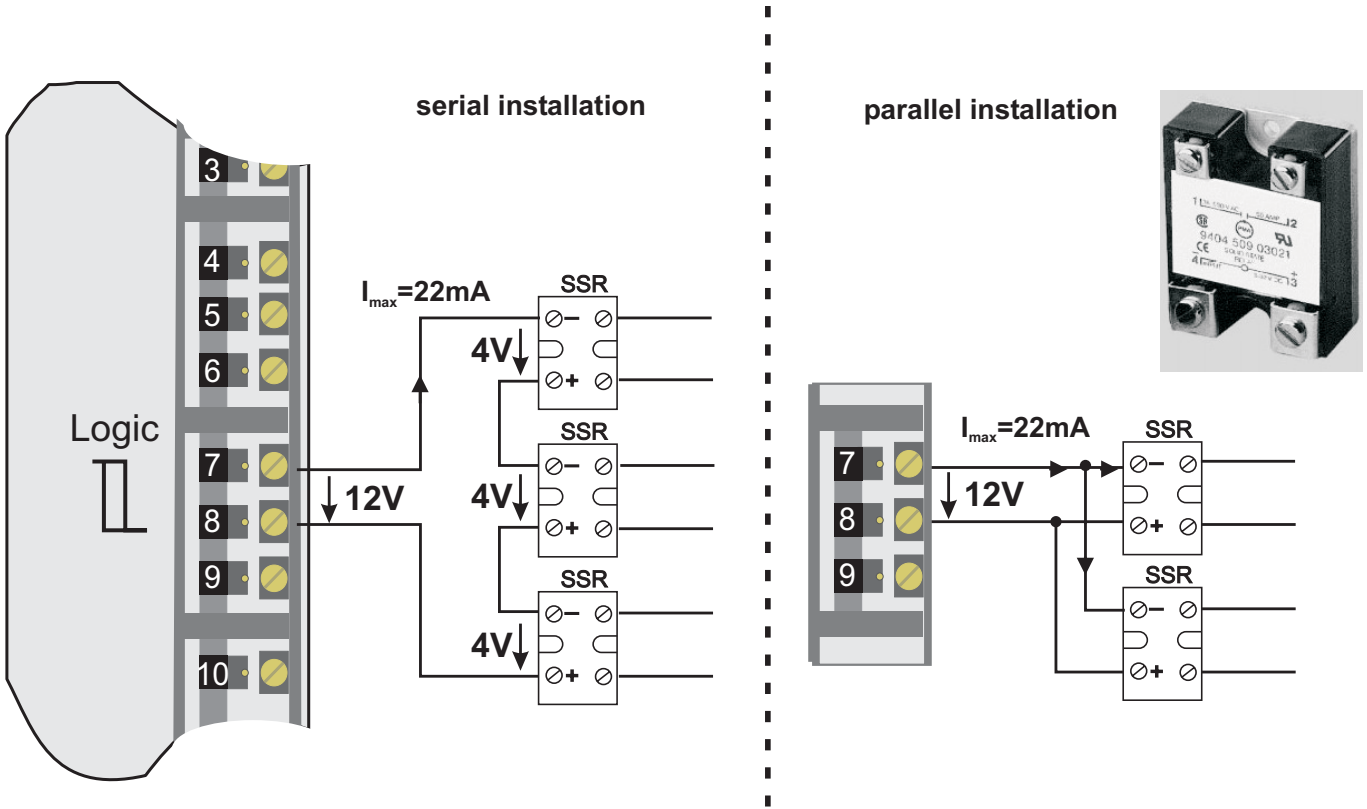

9 RS485 interface (with RS232-RS485 interface converter) *

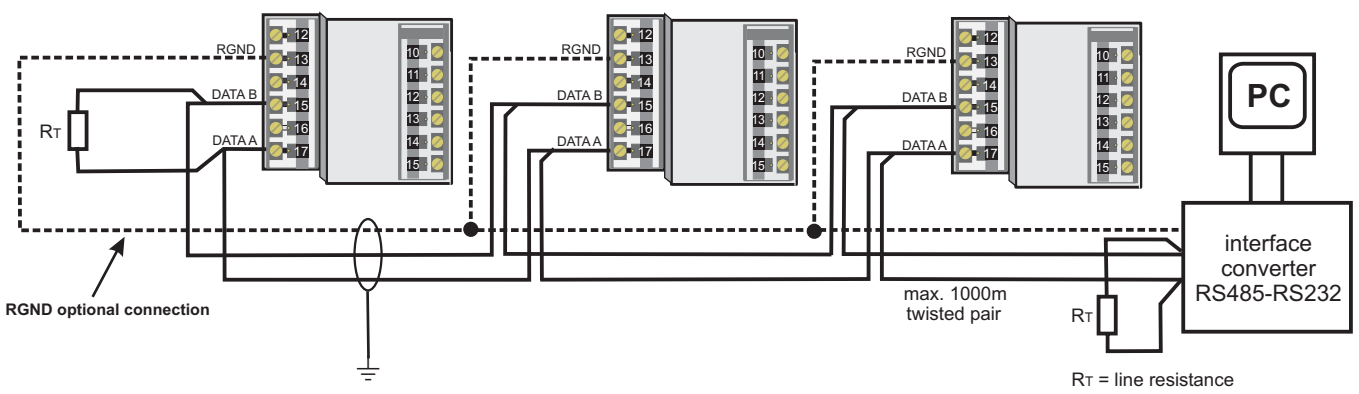

* Interface description Modbus RTU in separate manual: see page 41.

Connecting example Digital 280-1:

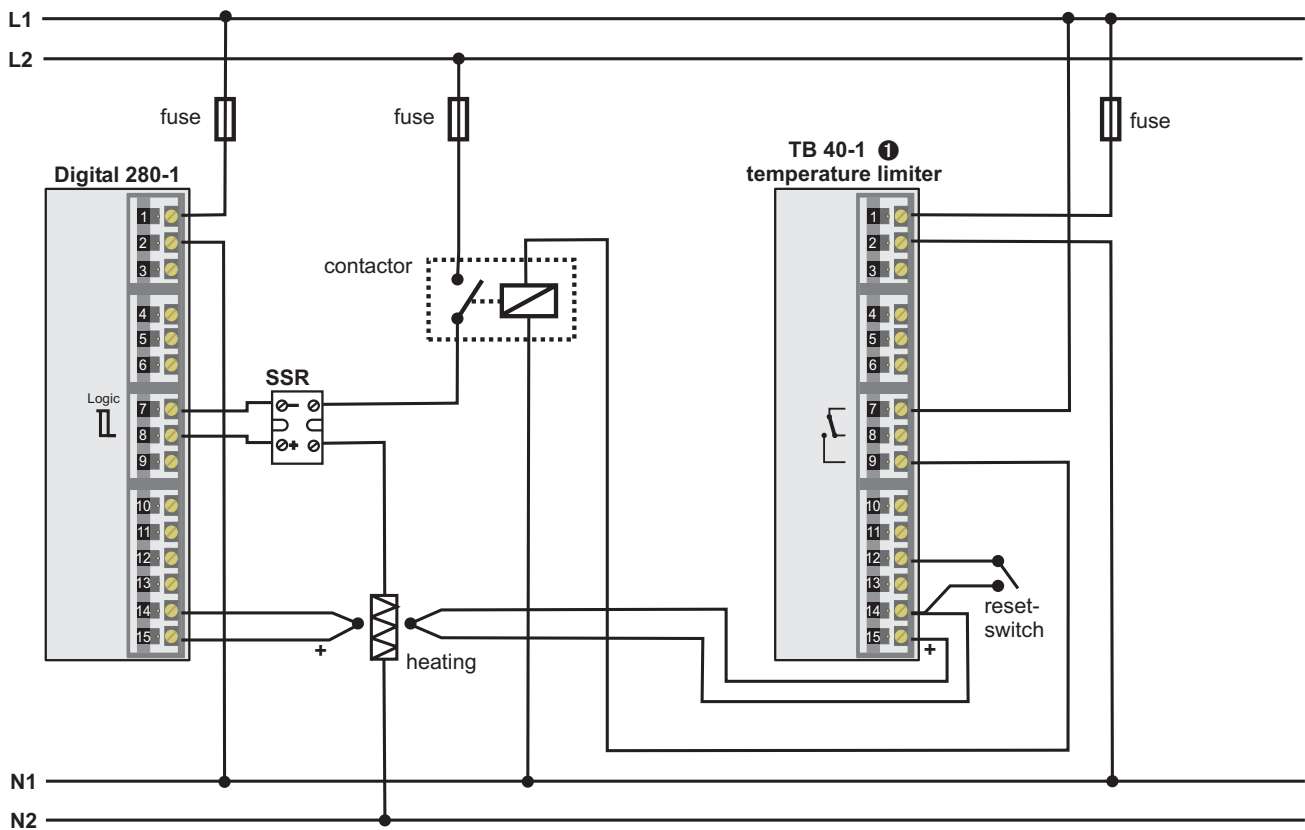

1 TB 40-1 temperature limiter
 standard-version (3 relay)
 TB40-100-0000D-000
 → further versions on demand



CAUTION:
 Using a temperature limiter is recommendable in systems where
 overtemperature implies a fire hazard or other risks.

3 Operation

3.1 Front view



- ① measured value display
- ② statuses of switching outputs $OUT. 1 \dots 3$ (or alarm statuses)
- ③ lit with self-tuning activated
- ④ lit with tare or sample & hold function activated
- ⑤ lit with entry in the error list
- ⑥ function-key
- ⑦ down-key
- ⑧ up-key
- ⑨ enter-key: calls up extended operating level/ errorlist
- ⑩ pc connection for BlueControl (engineering-tool)

i The measured value is displayed as standard. At parameter setting, configuration, calibration level and at the extended operating level, the display changes cyclically between parameter name and parameter value.

3.2 Behaviour after power-on

After supply voltage switch-on, the unit starts with the **operating level**. The unit is in the condition which was active before power-off.



3.3 Operating level

3.3.1 Min/max function

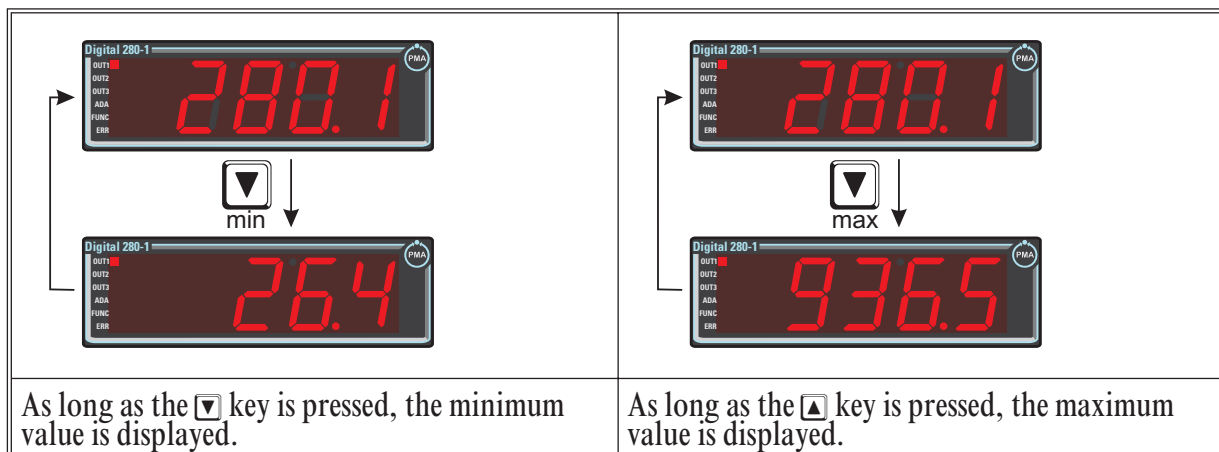
The minimum and maximum values are stored.





Deleting the minimum value

Keeping the  key pressed whilst actuating key  deletes the minimum value. Additionally, determination whether a digital input or key  should delete the minimum value is possible during configuration (*r E 5.L*).

Deleting the minimum and maximum values can be done also via interface.

Deleting the maximum value

Keeping the  key pressed whilst actuating key  deletes the maximum value. Additionally, determination whether a digital input or key  should delete the maximum value is possible during configuration (*r E 5.H*).

Deleting the minimum and maximum values can be done also via interface.

-  When switching off Digital 280-1, minimum and maximum values are deleted.

3.3.2 Tare function

When switching on the tare function, the instantaneous measured value is set to zero. In this case, measurement is continued with this offset. By switching off the tare function, the actual measured value is displayed again.

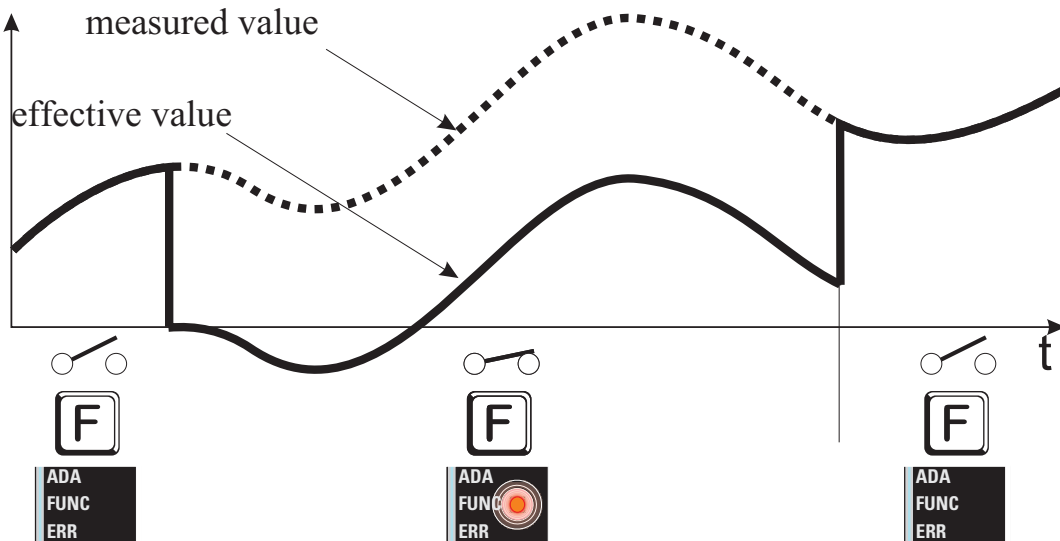

Tare can be activated during configuration ($FUNC \rightarrow FUNC.1 = 1$).

Dependent of configuration, tare can be made effective via one of the digital inputs di1, di2, di3, the \boxed{F} key or interface ($LOGI \rightarrow TARA$).

3.3.3 Sample&hold amplifier

With the sample & hold function activated, the measured value is held on the display. By switching off the sample & hold function, the actual measured value is displayed again.

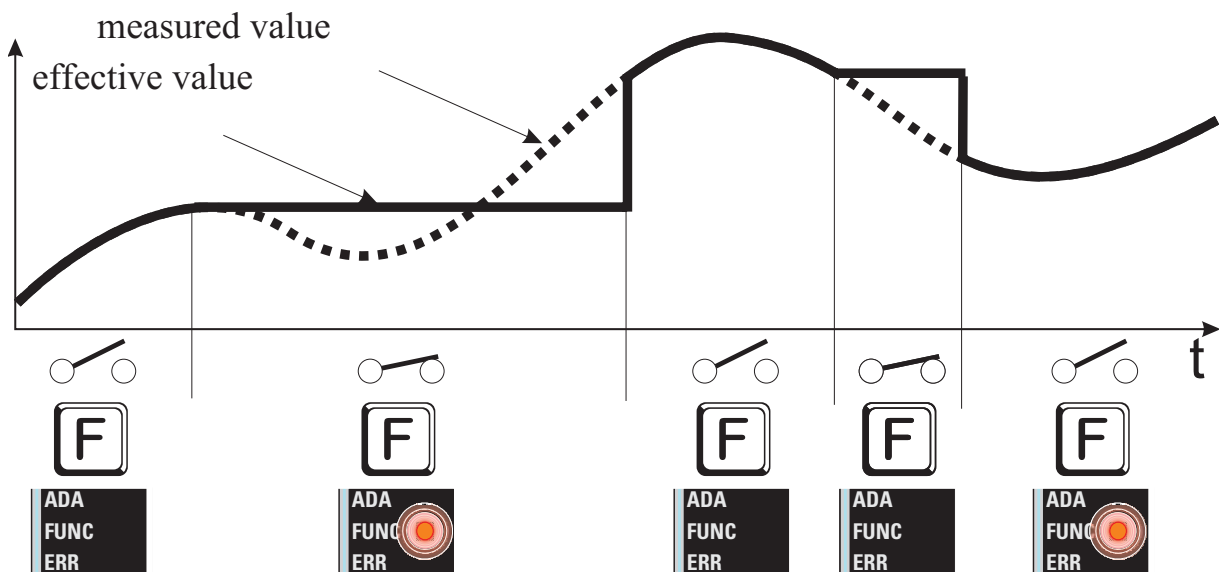

Sample & hold can be activated during configuration ($FUNC \rightarrow FUNC.1 = 2$).

Dependent of configuration, sample & hold can be made effective via one of the digital inputs di1, di2, di3, the \boxed{F} -key or via interface ($LOGI \rightarrow HOLD$).

3.3.4 O₂ measurement

For measurement, lambda probes (λ probes) are used.

The electromotive force (in Volt) supplied by the λ probes is dependent of the instantaneous oxygen content and of the temperature. Therefore, Digital 280-1 can display accurate measurement results only, provided that the probe temperature is known to the indicator.

Enter the temperature in °C in parameter tEP . When using heated λ probes, the probe temperature can be entered directly. When using non-heated λ probes, however, the displayed values can be accurate only for a narrow temperature band.



Unless the probe temperature is known, we recommend using our KS90-1 Oxygen (temperature measurement via a second input).

Configuration:

Adjust O₂ measurement in **function 1**:

$\text{Func} \rightarrow \text{Fnc.1}$	3	O2 measurement
--	---	----------------

Display: The displayed value is always a % value.

As it is mostly necessary to cover a wide measuring range, we recommend adjusting a high number of digits behind the decimal point during configuration, whereby loss of high values is prevented due to floating decimal point display (0,0001 (1 ppm) to 99999 is possible).

Specify the number of digits behind the decimal point below **othr** :

$\text{othr} \rightarrow \text{dP}$	0	0 digits behind the decimal point
	1	1 digit behind the decimal point
	2	2 digits behind the decimal point
	3	3 digits behind the decimal point
	4	4 digits behind the decimal point

Adjust the sensor type to one of the high-impedance voltage inputs in **InP**:

		Specification in BlueControl	Effective measuring range
$\text{InP.1} \rightarrow \text{StYP}$	41	Special (0...100 mV)	-2,5...115 mV
	42	Special (0...1000 mV)	-25...1150 mV
	43	Special (-25...90 mV)	
	44	Special (-500...500 mV)	

These high-impedance inputs are not provided with break monitoring. If necessary, measurement input protection is possible via limit value processing.

3.3.5 Extended operating level

The content of the extended operating level is determined by means of BlueControl (engineering tool). Parameters which are important or which are used frequently can be copied into the extended operating level.

Actuating key  switches to the first value of the extended operating level (may be preceded by error list or set-point).

The selected parameters can be changed by pressing keys  and .

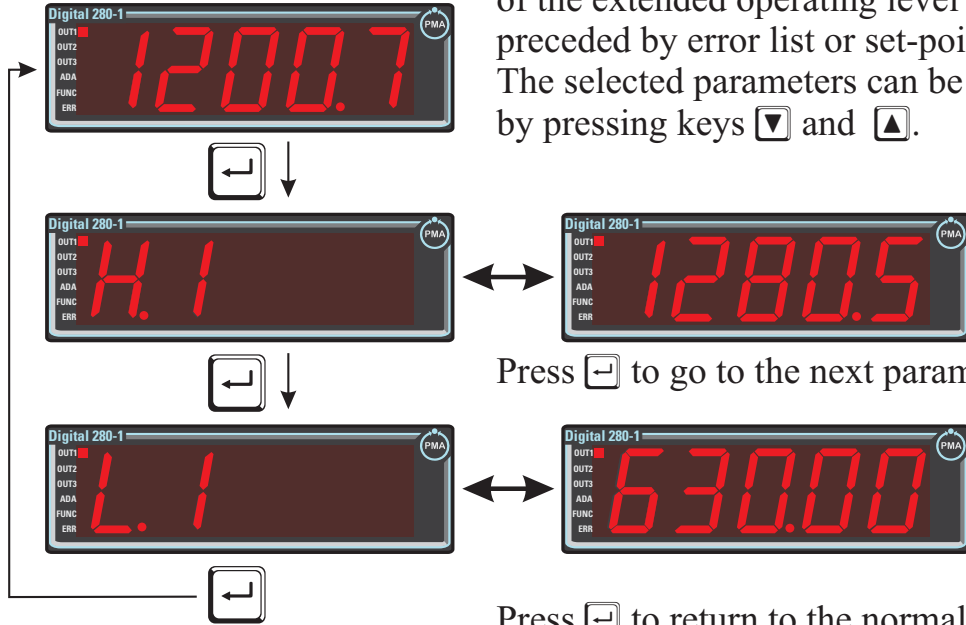

Press  to go to the next parameter.

Press  to return to the normal display after the last parameter .

3.3.6 Alarm handling

Max. three alarms can be configured and assigned to the individual outputs. Generally, outputs **Out.1**... **Out.3** can be used each for alarm signalling. If more than one signal is linked to one output the signals are OR linked. Each of the 3 limit values **L.n.1** ... **L.n.3** has 2 trigger points **H.x** (Max) and **L.x** (Min), which can be switched off individually (parameter = "OFF"). Switching difference **HYS.x** of each limit value is adjustable.

Operating principle absolut alarm
L.1 = OFF

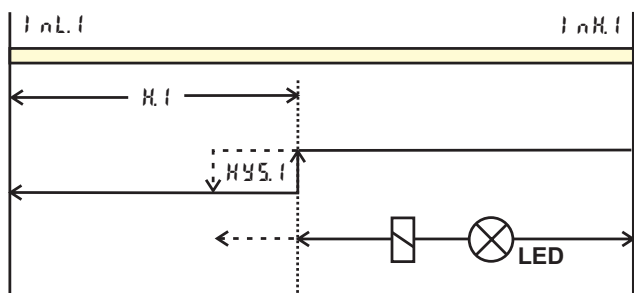

Operating principle relative alarm
L.1 = OFFF

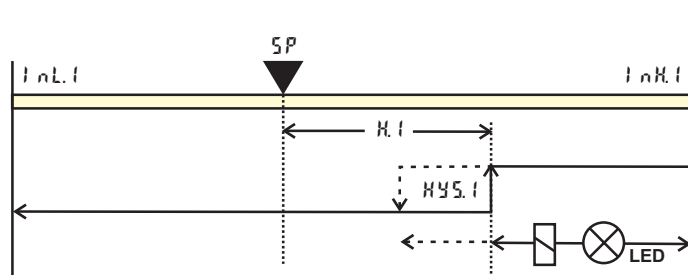

H.1 = OFF

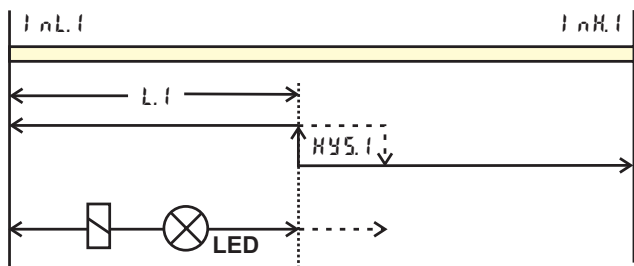

H.1 = OFFF

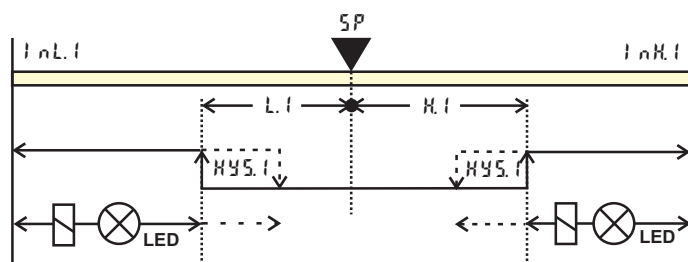
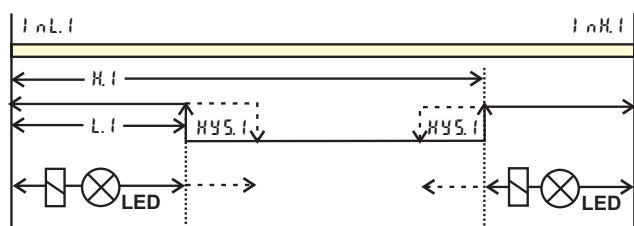
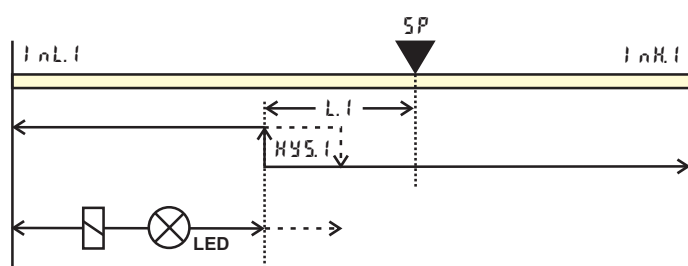

normally closed (**CONF / Out.x / OAct = 0**)

normally open (**CONF / Out.x / OAct = 1**)

i The variable to be monitored can be selected separately for each alarm via configuration

The following variables can be monitored:

- process value
- control deviation xw (process value - set-point)
- control deviation xw + suppression after start-up or set-point change

As there is automatically a control deviation after starting up and after set-point changes, however, the alarm is suppressed, until the signal was within the limits once.

- Set-point
- Correcting variable y (controller output signal)



i If measured value monitoring + alarm status storage is chosen (`CONF / L iñ / Func.x = 2`), the alarm relay remains switched on until the alarm is reset in the error list (`L iñ 1..3 = 1`) or via interface.

3.4 Maintenance manager / Error list

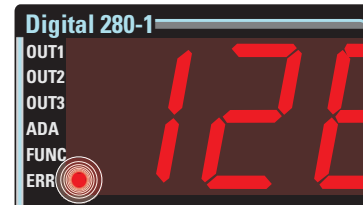
In case of one or several errors, the extended operating level always starts with the error list. A current entry into the error list (alarm or error) is displayed by the Err LED in the display.



For displaying the error list, pressing 1x  is necessary. (with configuration as a controller, press 2x .

Err LED status	Signification	Proceed as follows
blinks	Alarm due to existing error	- Determine the error type in the error list via the error number - Remove the error
lit	Error removed, Alarm not acknowledged	- Acknowledge the alarm in the error list pressing key  or  - The alarm entry was deleted.
off	No error, all alarm entries deleted	

i Saved alarms (Err-LED is lit) can be acknowledged and deleted with the digital input di1/2/3 or the -key.

Configuration, see page 31: `CONF / LOG1 / Error`

i If an alarm is still valid that means the cause of the alarm is not removed so far (Err-LED blinks), then other saved alarms can not be acknowledged and deleted.

Error status	Signification	
2	Existing error	Change to error status 1 after error removal
1	Stored error	Change to error status 0 after acknowledgement in error list
0	No error/message	not visible, except with acknowledgement

4 Controller

In addition to the simple indicator function, Digital 280-1 can be used also as a signaller or an on/off controller, as a two point or a continuous controller.

Prerequisite: Digital 280-1 is fitted with option “with outputs” and is configured for the controller function.

Configuration:

Function 2 provides selection between indicator and controller:



4.1 Operation

Adjusting the set-point

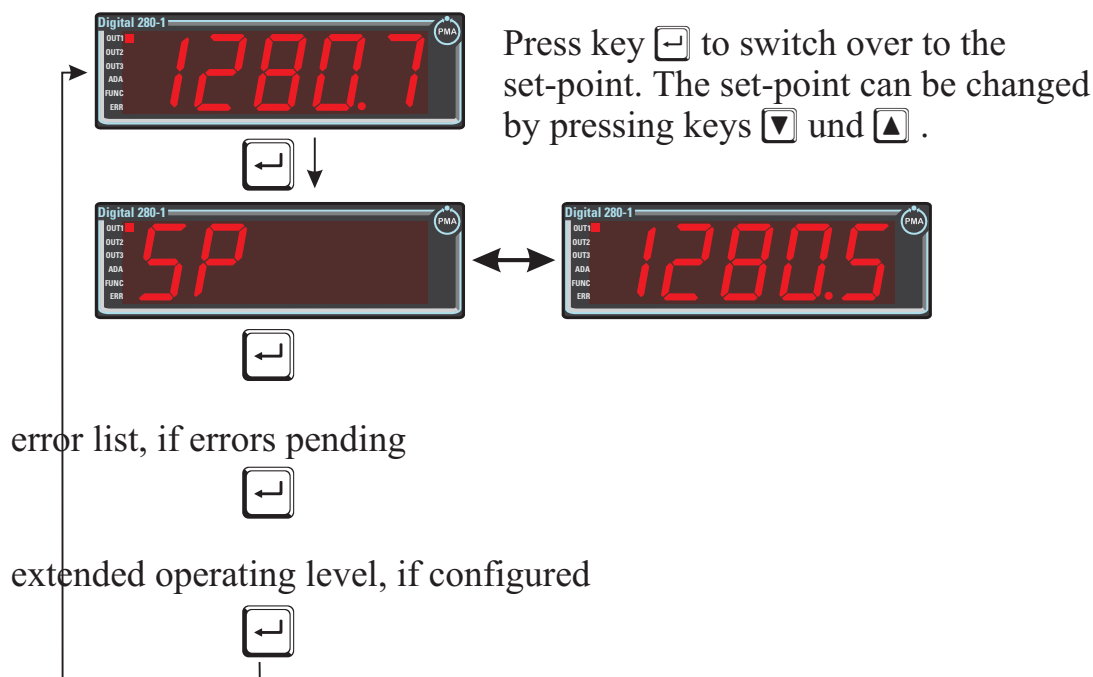



4.2 Control parameters



The range of different processes to be controlled is very wide, from very fast pressure control to very slow thermal processes such as control of a blast furnace. As the controller behaviour has to be different with each of these processes, the control parameters must be adjusted for the relevant process individually. Adjustment can be done either manually or by the controller itself.

4.3 Self-tuning

After starting by the operator, the controller makes a self-tuning attempt. The controller uses the process characteristics for quick line-out to the set-point without overshoot.

-  Self-tuning start can be locked via BlueControl (engineering tool) (`PLoc`).
-  `ti` and `td` are taken into account only, if they were $\neq 0FF$ previously.

4.3.1 Self-tuning start (+)

The operator can start self-tuning at any time. For this, keys  and  must be pressed simultaneously. The AdA LED starts blinking.

The controller outputs 0% or `YLo`, waits until the process is at rest and starts self-tuning (AdA LED lit permanently).





The self-tuning attempt is started when the following prerequisite is met:

- The difference between process value \leftrightarrow set-point must be $\geq 10\%$ of the set-point range (`SPHi` - `SPLo`) (with inverse action: process value smaller than set-point, with direct action: process value higher than set-point).

After successful self-tuning, the AdA-LED is off and the controller continues operating with the new control parameters.

4.3.2 Self-tuning cancellation

By the operator:

Self-tuning can always be cancelled by the operator. For this, press  and  key simultaneously. The controller continues operating with the old parameters.

By the controller:

If the Err LED starts blinking whilst self-tuning is running, successful self-tuning is prevented due to the control conditions. In this case, self-tuning was cancelled by the controller.



Dependent of control type, the output status is:

- 3-pnt. stepping controller:
actuator is closed (0% output)
- 2-pnt./ 3-pnt./ continuous controller:
If self-tuning was started from the automatic mode, the controller output is 0%. With self-tuning started from manual mode, the controller output is Y2.

Error-Status Selfoptimization

Error status	Description	Behaviour
0	No error	
3	Faulty control action	Re-configure controller (inverse \leftrightarrow direct)
4	No response of process variable	The control loop is perhaps not closed: check sensor, connections and process
5	Low reversal point	Increase (ADA.H) max. output limiting Y.Hi or decrease (ADA.C) min. output limiting Y.Lo
6	Danger of exceeded set-point (parameter determined)	If necessary, increase (inverse) or reduce (direct) set-point
7	Output step change too small ($dy > 5\%$)	Increase (ADA.H) max. output limiting Y.Hi or reduce (ADA.C) min. output limiting Y.Lo
8	Set-point reserve too small	Increase set-point (inverse), reduce set-point (direct) or increase set-point range(r PArA / SEtp / SP.LO and SP.Hi)

4.3.3 Acknowledgement procedures in case of unsuccessful self-tuning

- Press keys  and  simultaneously:
The controller continues controlling using the old parameters
The Err LED continues blinking, until the self-tuning error was acknowledged in the error list.
- Press key  :
Display of error list at extended operating level. After acknowledgement of the error message, the controller continues control using the old parameters.

4.3.4 Examples for self-tuning attempts

4.3.5 (controller inverse, heating or heating/cooling)

Start: heating power switched on

Heating power Y is switched off (①).

When the change of process value X was constant during one minute (②), the power is switched on (③).

At the reversal point, the self-tuning attempt is finished and the new parameter are used for controlling to set-point W.

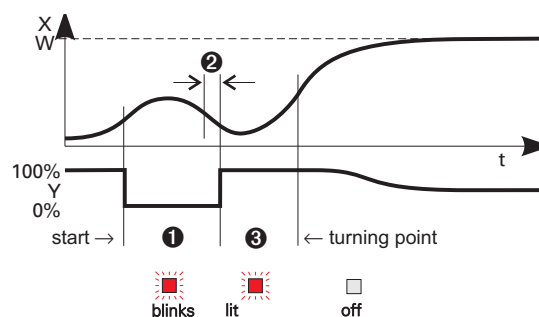

Start: heating power switched off

The controller waits 1,5 minutes (❶). Heating power Y is switched on (❷). At the reversal point, the self-tuning attempt is finished and control to the set-point is using the new parameters.

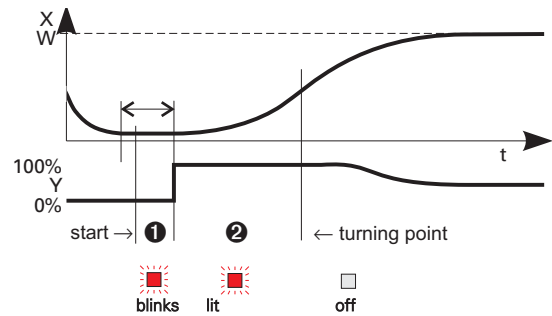

Start: at set-point

Heating power Y is switched off (❶). If the change of process value X was constant during one minute and the control deviation is > 10% of $SP.H$ - $SP.LD$ (❷), the power is switched on (❸). At the reversal point, the self-tuning attempt is finished, and control to set-point W is using the new parameters.

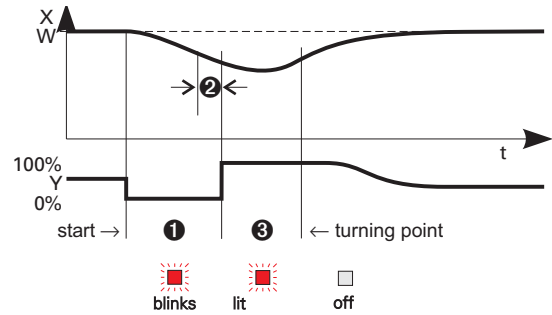

4.4 Manual tuning

The optimization aid should be used with units on which the control parameters shall be set without self-tuning.

For this, the response of process variable x after a step change of correcting variable y can be used. Frequently, plotting the complete response curve (0 to 100%) is not possible, because the process must be kept within defined limits. Values T_g and x_{max} (step change from 0 to 100 %) or Δt and Δx (partial step response) can be used to determine the maximum rate of increase V_{max} .

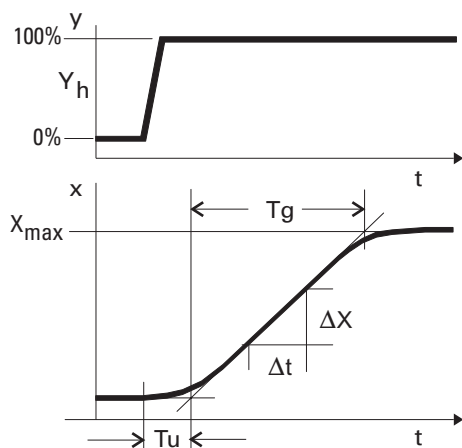

- y = correcting variable
 - Y_h = control range
 - T_u = delay time (s)
 - T_g = recovery time (s)
 - X_{max} = maximum process value
- $$V_{max} = \frac{X_{max}}{T_g} = \frac{\Delta x}{\Delta t} \triangleq \text{max. rate of increase of process value}$$

The control parameters can be determined from the values calculated for delay time T_u , maximum rate of increase v_{max} , control range X_h and characteristic K according to the **formulas** given below. Increase X_p , if line-out to the set-point oscillates.

Parameter adjustment effects

Parameter	Control	Line-out of disturbances	Start-up behaviour
$Pb1$	higher	increased damping	slower line-out
	lower	reduced damping	faster line-out
$td1$	higher	reduced damping	faster response to disturbances
	lower	increased damping	slower response to disturbances
$ti1$	higher	increased damping	slower line-out
	lower	reduced damping	faster line-out

$$K = v_{max} * T_u$$

With 2-point and 3-point controllers, the cycle time must be adjusted to $t1 / t2 \approx 0,25 * T_u$

Formulas

controller behavior	$Pb1$ [phy. units]	$td1$ [s]	$ti1$ [s]
PID	$1,7 * K$	$2 * T_u$	$2 * T_u$
PD	$0,5 * K$	T_u	OFF
PI	$2,6 * K$	OFF	$6 * T_u$
P	K	OFF	OFF
3-point-stepping	$1,7 * K$	T_u	$2 * T_u$

4.5 Operating structure

After supply voltage switch-on, the controller starts with the **operating levels**.

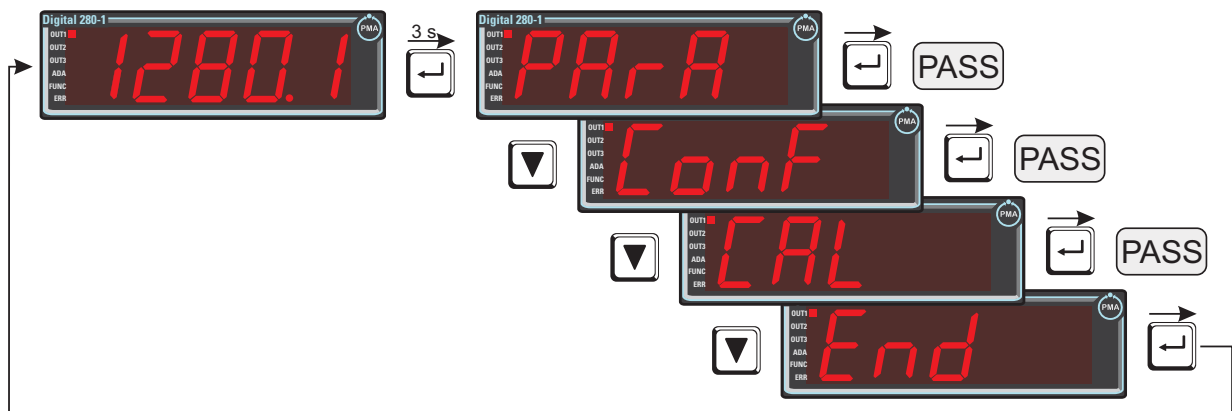

i **PArA** - level:
At **PArA** - level, the right decimal point of the upper display line is *lit continuously*.

i **Conf** - level:
At **Conf** - level, the right decimal point of the upper display line *blinks*

PASS



When safety switch **Loc** is open, only the levels enabled by means of BlueControl (engineering tool) are visible and accessible by entry of the password adjusted by means of BlueControl (engineering tool). Individual parameters accessible without password must be copied to the extended operating level.

Factory setting: Safety switch **Loc** closed: all levels accessible without restriction, password **PASS = OFF**.



Safety switch Loc	Password entered with BluePort®	Function disabled or enabled with BluePort®	Access via the instrument front panel:
closed	OFF / password	disabled / enabled	enabled
open	OFF / password	disabled	disabled
open	OFF	enabled	enabled
open	Password	enabled	enabled after password entry

5 Configuration level

5.1 Configuration survey

CONF Configuration level									
	Func Functions	Input	Limits	Output 1	Output 2	Output 3	Digital Inputs	Display, operation, interface	End
 	Fnc.1	StYP	Fnc.1	ORct	See output 1	Q.tYP	L.r	bRud	
	Fnc.2	SL in	Src.1	Y.1		ORct	Err.r	Rddr	
	CFnc	Corr	Fnc.2	L in.1		Y.1	tArR	Prty	
	CRct		Src.2	L in.2		L in.1	HOLD	dELY	
	rngL		Fnc.3	L in.3		L in.2	rESL	Unit	
	rngH		Src.3	FR.v1		L in.3	rESH	dP	
						FR.v1	d.Fn	dISP	
					Out.0		C.dEL		
					Out.1				
					QSrc				

Adjustment:

- The configurations can be adjusted by means of keys .
- Transition to the next configuration is by pressing key .
- After the last configuration of a group, done is displayed and followed by automatic change to the next group

 Return to the beginning of a group by pressing the  key for 3 sec.

5.2 Configuration

Dependent of instrument version and configuration, spare parameters are not displayed.

Func

name	value range	description	default
Func.1		function 1	0
	0	no function	
	1	tare - function	
	2	sample & hold	
	3	O2 - measuring	
Func.2		function 2	0
	0	indicator	
	1	controller	
CFnc		controller behavior (algorithm)	1
	0	on/off controller e.g. signaller with one output	
	1	PID-controller (2-point and continuous)	
CRct		operating principle of the controller	0
	0	inverse, e.g. heating	
	1	direct, e.g. cooling	
rnl	-19999...99999	X0 (lower controlrange limit) ①	-100
rnh	-19999...99999	X100 (upper controlrange limit) ①	1200

① rnl and rnh indicate the control range to which self-tuning refers.

InP

name	value range	description	default
StYP		sensortype	1
	0	thermocouple type L (-100...900°C), Fe-CuNi DIN	
	1	thermocouple type J (-100...1200°C), Fe-CuNi	
	2	thermocouple type K (-100...1350°C), NiCr-Ni	
	3	thermocouple type N (-100...1300°C), Nicrosil-Nisil	
	4	thermocouple type S (0...1760°C), PtRh-Pt10%	
	5	thermocouple type R (0...1760°C), PtRh-Pt13%	
	6	thermocouple type T (-200...400°C), Cu-CuNi	
	7	thermocouple type C (0...2315°C), W5%Re-W26%Re	
	8	thermocouple type D (0...2315°C), W3%Re-W25%Re	
	9	thermocouple type E (-100...1000°C), NiCr-CuNi	
	10	thermocouple type B (0/100...1820°C), PtRh-Pt6%	
	18	thermocouple Sonder (linearization necessary)	
	20	pt100 (-200.0 ... 100.0 °C)	
	21	pt100 (-200.0 ... 850.0 °C)	
	22	pt1000 (-200.0...8500.0 °C)	
	23	special 0...4500 Ohm (preset to KTY11-6)	
	24	special 0...450 Ohm (scaling necessary)	
	30	0...20mA / 4...20 mA (scaling necessary → page 36)	
	40	0...10V / 2...10 V (scaling necessary → page36)	

name	value range	description	default
	41	special (-2,5...115 mV scaling necessary → page36)	
	42	special (-25...1150 mV scaling necessary → page 36)	
	43	special (-25...90 mV scaling necessary → page 36)	
	44	special (-500...500 mV scaling necessary → page 36)	
	45	special (-5...5 V scaling necessary → page 36)	
	50	potentiometer 0...160 Ohm	
	51	potentiometer 0...450 Ohm	
	52	potentiometer 0...1600 Ohm	
5.L in		linearization only adjustable with 5.L 4P: 18, 23, 24, 30, 40 ... 45	0
	0	none	
	1	Special linearization Editing the linearization table with BlueControl (engineering tool) is possible. The characteristic for KTY 11-6 temperature sensors is factory-set.	
Corr		measurement value correction / scaling	0
	0	no correction	
	1	offset-correction (in LR L - level)	
	2	2-point-correction (in LR L - level)	
	3	scaling (in PAR A - level)	
fAI1		forcing INP (only visible with BlueControl!)	0
	0	no forcing	
	1	forcing via interface	

L in

name	value range	description	default
Func.1		function of limit 1 (2, 3)	1
Func.2	0	switched off	
Func.3	1	measured value monitoring	
	2	measured value monitoring + storing of alarm status. A stored limit value can be set back via error list or digital input or [F] -key (→ LOGI / Err.r).	
	3	signal change	
	4	signal change + storing of alarm status. A stored limit value can be set back via error list or digital input or [F] -key (→ LOGI / Err.r).	
Src.1		source for limit value 1 (2, 3)	0
Src.2	0	process value = absolut alarm	
Src.3	1	control deviation Xw (processvalue - set-point) = relative alarm	
	2	control deviation Xw (=relative alarm) with suppression at start and with set-point change	
	3	measured value INP	
	6	set-point	
	7	y (controller output)	
Hour	OFF..999999	operating hours (only visible with BlueControl!)	OFF
Swit	OFF..999999	operation cycle number (only visible with BlueControl!)	OFF

Out.1 und Out.2

name	value range	description	default
OARct		circuit direction of output OUT1	0
	0	direct / open circuit principle	
	1	inverse / closed circuit principle	
Y.1		controller output Y1	0
	0	not active	
	1	active	
L.ln.1		message limit value 1/2/3	
L.ln.2	0	not active	
L.ln.3	1	active	Out.1/2/3
FR.ct		message INP error	0
	0	not active	
	1	active	
fOut		forcing OUT1 (2) (only visible with BlueControl!)	0
	0	no forcing	
	1	forcing via interface	

Out.3

name	value range	description	default
OETYP		signaltype OUT3	0
	0	relay / logic	
	1	0 ... 20 mA continuous	
	2	4 ... 20 mA continuous	
	3	0...10V continuous	
	4	2...10V continuous	
OARct		circuit direction of output OUT3 (only visible with O.TYP=0)	1
	0	direct / open circuit principle	
	1	inverse / closed circuit principle	
Y.1		controller output Y1 (only visible with O.TYP=0)	0
	0	not active	
	1	active	
L.ln.1		message limit value 1 (only visible with O.TYP=0)	1
	0	not active	
	1	active	
L.ln.2		message limit value 2/3 (only visible with O.TYP=0)	0
	0	not active	
	1	active	
FR.ct		message INP-error (only visible with O.TYP=0)	1
	0	not active	
	1	active	
Out.0	-19999... 99999	scaling of analog output for 0% (0/4mA e.g. 0/2V, only visible with O.TYP=1..5)	0
Out.1	-19999... 99999	scaling of analog output for 100% (20mA bzw. 10V, only visible with O.TYP=1..5)	100

name	value range	description	default
O.Src		signalsource for analog output OUT3 (only visible with O.TYP=1..5)	1
	0	not active	
	1	controller output y1 (continuous)	
	3	process value	
	4	effective set-point Weff	
	5	control deviation xw (process value - set-point)	
fOut		forcing OUT3 (only visible with BlueControl!)	0
	0	no forcing	
	1	forcing via interface	

LOGI

name	value range	description	default
Lsr		local / remote switch-over (remote: adjustment of all values via front is blocked)	0
	0	no function (switch-over via interface is possible)	
	1	always active	
	2	di1 switches	
	3	di2 switches(only visible with OPTION)	
	4	di3 switches(only visible with OPTION)	
Errr		reset of all stored messages of the errorlist	0
	0	no function (switch-over via interface is possible)	
	2	di1 switches	
	3	di2 switches (only visible with OPTION)	
	4	di3 switches (only visible with OPTION)	
	5	<input type="checkbox"/> -key switches	
ErrA			0
	0	no function (switch-over via interface is possible)	
	2	di1 switches	
	3	di2 switches (only visible with OPTION)	
	4	di3 switches (only visible with OPTION)	
	5	<input type="checkbox"/> -key switches	
Hold			0
	0	no function (switch-over via interface is possible)	
	2	di1 switches	
	3	di2 switches (only visible with OPTION)	
	4	di3 switches (only visible with OPTION)	
	5	<input type="checkbox"/> -key switches	
rESL			0
	0	no function (switch-over via interface is possible)	
	2	di1 switches	
	3	di2 switches (only visible with OPTION)	
	4	di3 switches (only visible with OPTION)	
	5	<input type="checkbox"/> -key switches	

name	value range	description	default
rESK			0
	0	no function (switch-over via interface is possible)	
	2	di1 switches	
	3	di2 switches (only visible with OPTION)	
	4	di3 switches (only visible with OPTION)	
dIFn		function of digital inputs (valid for all inputs)	0
	0	direct	
	1	inverse	
	2	keyfunction (adjustable for 2-point-operation with interface and di1/2/3 or front-key)	
fDI1		forcing di1/di2/di3 (only visible with BlueControl!)	0
fDI2	0	no forcing	
fDI3	1	forcing via interface	

othr

name	value range	description	default
bAud		baudrate of interface (only visible with OPTION)	2
	0	2400 baud	
	1	4800 baud	
	2	9600 baud	
Addr	1...247	adresse of Schnittstelle (only visible with OPTION)	1
Prty		parity of data on interface (only visible with OPTION)	1
	0	no parity (2 stopbits)	
	1	even parity	
	2	odd parity	
dELY	0...200	response delay [ms] (only visible with OPTION)	0
Unit		unit	1
	0	no unit	
	1	°C	
dP		dezimalpoint (max. dezimalpoint)	0
	0	no decimalplace	
	1	1 decimalplace	
	2	2 decimalplaces	
	3	3 decimalplaces	
dISP		measuring value display	1
	1	full display resolution	
	2	display resolution= 2 digits	
	3	display resolution= 5 digits	
	4	display resolution= 10 digits	
	5	display resolution= 20 digits	
	6	display resolution= 50 digits	
7	display resolution= 100 digits		

name	value range	description	default
CDL	0..200	modem delay [ms]	0
FrEq		switch-over 50/60 Hz (only visible with BlueControl!)	0
	0	netfrequency 50 Hz	
	1	netfrequency 60 Hz	
IAAd		blocked selfoptimization (only visible with BlueControl!)	0
	0	free	
	1	blocked	
IExo		extended operation level blocked (only visible with BlueControl!)	0
	0	free	
	1	blocked	
ILat		suppression error memory	
	0	free	
	1	blocked	
Pass	OFF...99999	password -19999 ...99999	OFF
IPar		parameterlevel blocked (only visible with BlueControl!)	1
	0	free	
	1	blocked	
ICnf		configurationlevel blocked (only visible with BlueControl!)	1
	0	free	
	1	blocked	
ICal		calibrationlevel blocked (only visible with BlueControl!)	1
	0	free	
	1	blocked	

 **Resetting the controller configuration to factory setting (Default)**
 → chapter 11.1 (page 47)

 **BlueControl - the engineering tool for the BluePort® controller series**

Three engineering tools with different functionality facilitating Dig 280-1 configuration and parameter setting are available (see chapter 8 : *Accessory equipment with ordering information*). In addition to configuration and parameter setting, the engineering tools are used for data acquisition and offer long-term storage and print functions. The engineering tools are connected to Dig 280-1 via the front-panel interface "BluePort®" by means of PC (Windows 95 / 98 / NT) and a PC adaptor.

Description BlueControl: see chapter 8: *BlueControl* (page 40)

5.3 Configuration examples

5.3.1 On-Off controller / Signaller (inverse)

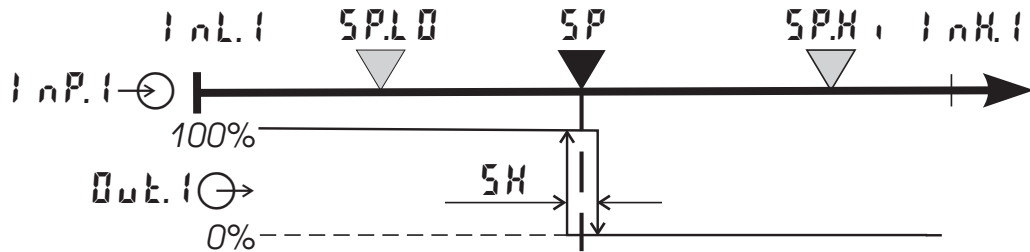

<code>CONF / ENTR:</code>	<code>SPFn</code>	<code>= 0</code>	set-point controller
	<code>CFnc</code>	<code>= 0</code>	signaller with one output
	<code>CRct</code>	<code>= 0</code>	inverse action
			(e.g. heating applications)
<code>CONF / OUT.1:</code>	<code>ORct</code>	<code>= 0</code>	action <code>Out.1</code> direct
	<code>Y.1</code>	<code>= 1</code>	control output Y1 active
<code>PRrR / ENTR:</code>	<code>SH</code>	<code>= 0...9999</code>	switching difference (symmetrical to the trigger point)
<code>PRrR / SEtP:</code>	<code>SP.L0</code>	<code>= -1999...9999</code>	set-point limit low for Weff
	<code>SP.H0</code>	<code>= -1999...9999</code>	set-point limit high for Weff

For direct signaller action, the controller action must be changed (`CONF / ENTR / CRct = 1`)

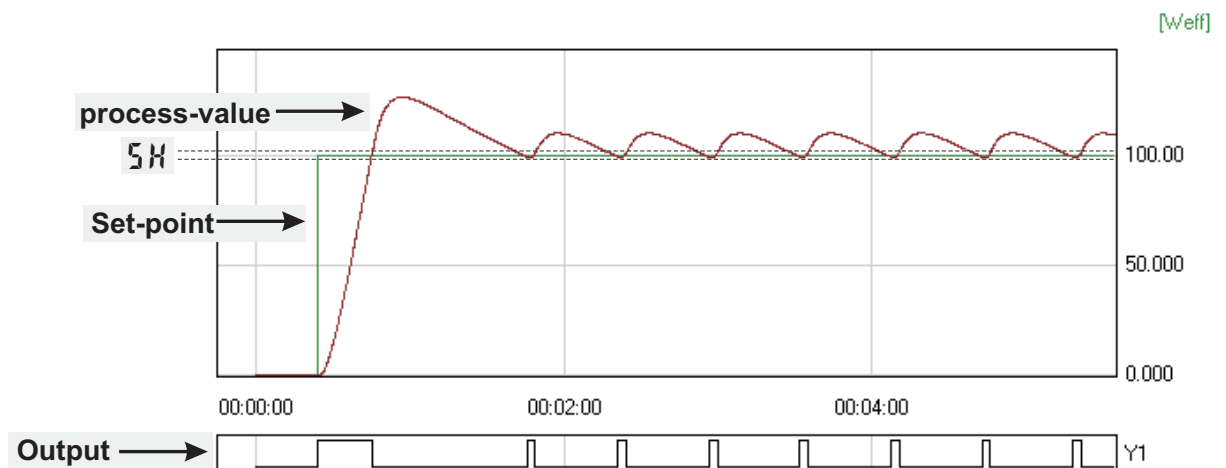

5.3.2 2-point controller (inverse)

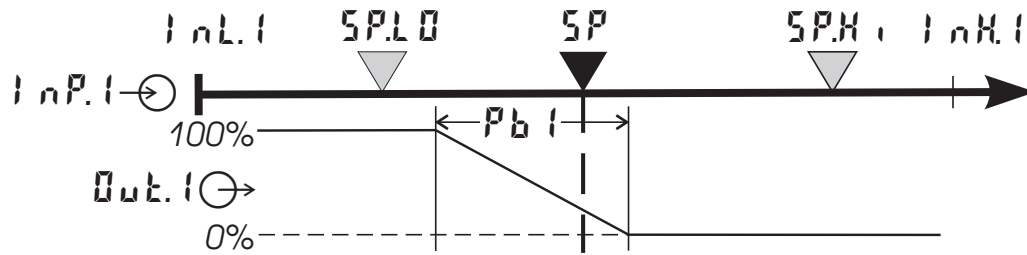

<code>CONF / ENTR:</code>	<code>SPFn=0</code>	set-point controller
	<code>CFnc = 1</code>	2-point controller (PID)
	<code>CAct = 0</code>	inverse action
		(e.g. heating applications)
<code>CONF / OUT.1:</code>	<code>ORct = 0</code>	action <code>Out.1</code> direct
	<code>Y1 = 1</code>	control output Y1 active
<code>PARA / ENTR:</code>	<code>Pb1 = 0,1...9999</code>	proportional band 1 (heating)
		in units of phys. quantity (e.g. °C)
	<code>t1 = 1...9999</code>	integral time 1 (heating) in sec.
	<code>td1 = 1...9999</code>	derivative time 1 (heating) in sec.
	<code>t1 = 0,4...9999</code>	min. cycle time 1 (heating)
<code>PARA / SEtP:</code>	<code>SP.L0 = -1999...9999</code>	set-point limit low for Weff
	<code>SP.H0 = -1999...9999</code>	set-point limit high for Weff

i For direct action, the controller action must be changed (`CONF / ENTR / CAct = 1`).

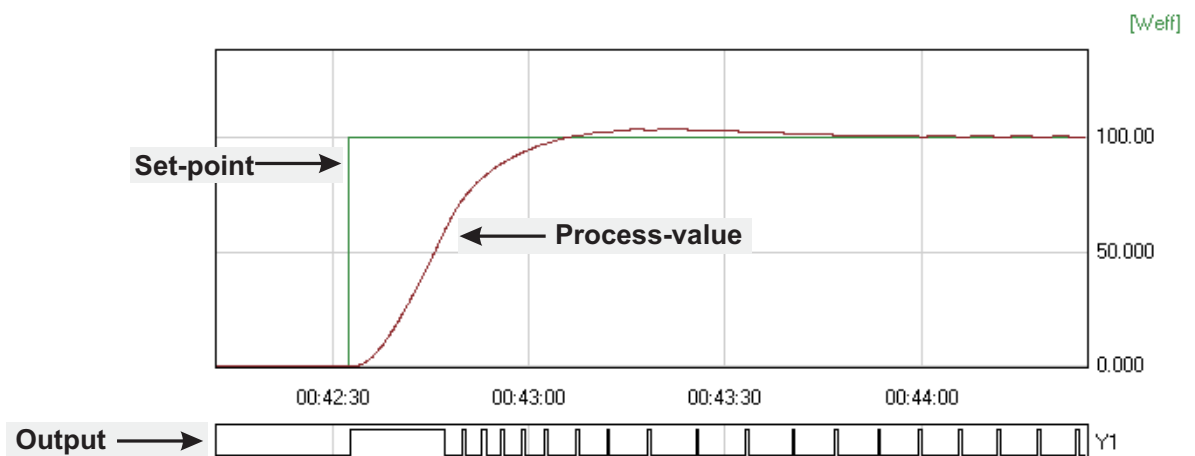

5.3.3 Continuous controller (inverse)

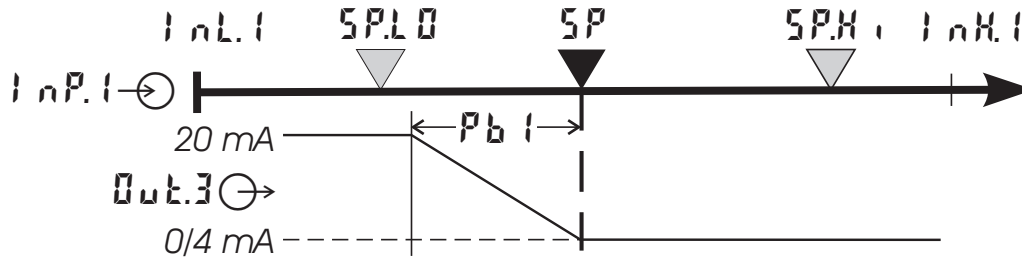

<code>CONF / ENTR:</code>	<code>SPFN=0</code>	set-point controller
	<code>CFNC = 1</code>	continuous controller (PID)
	<code>CACT = 0</code>	inverse action
		(e.g. heating applications)
<code>CONF / OUT.3:</code>	<code>OUTYP = 1/2</code>	<code>OUT.3</code> type (0/4 ... 20mA)
	<code>OUT.0 = -1999...9999</code>	scaling analog output 0/4mA
	<code>OUT.1 = -1999...9999</code>	scaling analog output 20mA
<code>PARA / ENTR:</code>	<code>Pb1 = 0,1...9999</code>	proportional band 1 (heating)
		in units of phys. quantity (e.g. °C)
	<code>ti1 = 1...9999</code>	integral time 1 (heating) in sec.
	<code>td1 = 1...9999</code>	derivative time 1 (heating) in sec.
	<code>tl = 0,4...9999</code>	min. cycle time 1 (heating)
<code>PARA / SEtP:</code>	<code>SP.L0 = -1999...9999</code>	set-point limit low for Weff
	<code>SP.H0 = -1999...9999</code>	set-point limit high for Weff

i For direct action of the continuous controller, the controller action must be changed (`CONF / ENTR / CACT = 1`).

i To prevent control outputs `OUT.1` and `OUT.2` of the continuous controller from switching simultaneously, the control function of outputs `OUT.1` and `OUT.2` must be switched off (`CONF / OUT.1` and `OUT.2 / Y.1` and `Y.2 = 0`).

5.3.4 Digital 280-1 with measured value output

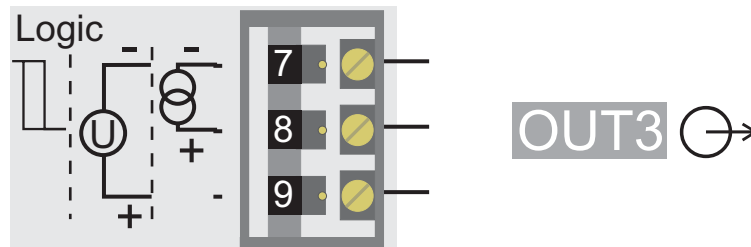
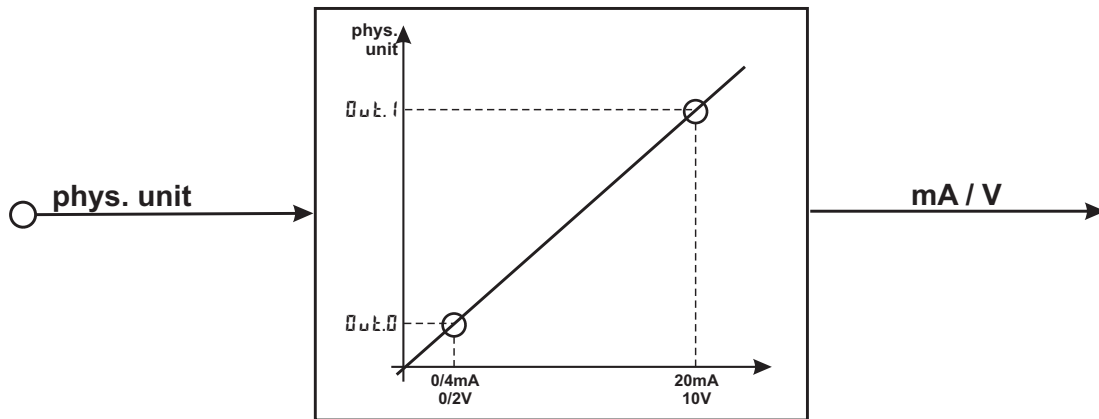

<code>CONF / Out.3:</code>	<code>Out.P</code>	<code>= 1</code>	<code>Out.3</code>	<code>0...20mA continuous</code>
		<code>= 2</code>	<code>Out.3</code>	<code>4...20mA continuous</code>
		<code>= 3</code>	<code>Out.3</code>	<code>0...10V continuous</code>
		<code>= 4</code>	<code>Out.3</code>	<code>2...10V continuous</code>
	<code>Out.0</code>	<code>= -1999...9999</code>	scaling <code>Out.3</code>	
			for <code>0/4mA</code> or <code>0/2V</code>	
	<code>Out.1</code>	<code>= -1999...9999</code>	scaling <code>Out.3</code>	
			for <code>20mA</code> or <code>10V</code>	
	<code>Out.c</code>	<code>= 3</code>	signal source for <code>Out.3</code>	is the process value

6 Parameter setting level

6.1 Parameter survey

Depending on unit version and configuration spare parameters are not shown.

PARAM Parameter-Level				
	Func	Input	Limits	End
▲	ENP	INL	L.1	
▼	Pb1	DUH	H.1	
	EL	INH	HYS.1	
	Ed1	DUH	dEL.1	
	EL	EF	L.2	
	SH	b.F	H.2	
	Y2	Exc	HYS.2	
	YLo		dEL.2	
	YH,		L.3H.3	
	YD		HYS.3	
	SPLO		HYS.3	
	SPH,		dEL.3	

Adjustment:

- The parameters can be adjusted by means of keys ▲▼
- Transition to the next parameter is by pressing key →
- After the last parameter of a group, donE is displayed, followed by automatic change to the next group.



Return to the beginning of a group is by pressing the ← key for 3 sec.

If for 30 sec. no keypress is executed the controller returns to the process value and setpoint display (Time Out = 30 sec.)

6.2 Parameter

Func

name	value range	description	default
EEAP	1...99999 ①	probetemperature for O ₂ measuring	650
Pb1	1...99999 ①	proportional band in phys. unit (z.B. °C)	100
t1	1...99999	reset time 1 [s] (t1=0 \triangleq off = switched off)	180
td1	1...99999	derivative time1 (heating) [s] (td1=0 \triangleq off = switched off)	180
t1	0,4...99999	min. cycle duration1 (heating) [s]. The smallest pulse duration is 1/4 x t1	10
SH	0...9999	neutral zone, e.g. switching difference signalunit [phys. unit]	2
Y2	-120...120	2nd control value [%] becomes effective with recognized process value error -FRI L	0
YLo	-120...120	lower controller value limit [%]	0
YHi	-120...120	upper controller value limit [%]	100
Y0	-120...120	working point for controller value [%]	0
SPLO	-99999...99999	lower set-point limit [phys. unit]	0
SPHi	-99999...99999	upper set-point limit [phys. unit]	100

① Valid for Conf/other/dP = 0. At dP = 1/2/3/4 so 0,1/0,01/0,001,0,0001.

LnP

name	value range	description	default
lnL	-19999...99999	input value of lower scaling point	0
ouL	-19999...99999	display value of lower scaling point	0
lnH	-19999...99999	input value of upper scaling point	20
ouH	-19999...99999	display value of upper scaling point	20
tF	0,1...999,9	filtertime constant [s]	0,5
bF	0...99999	filterbandwidth	5
Etc	0...100	external temperaturecompensation	OFF

L iñ

name	value range	description	default
L1	-19999...99999	lower limit value 1 (L.1 < -19999 \triangleq off)	-10
H1	-19999...99999	upper limit value 1 (H.1 < -19999 \triangleq off)	10
HYS.1	0...99999	hysteresis of limit value 1	1
dEL.1	0...99999	alarm 1 delay	0
L2	-19999...99999	lower limit value 2 (L.2 < -19999 \triangleq off)	OFF
H2	-19999...99999	upper limit value 2 (H.2 < -19999 \triangleq off)	OFF
HYS.2	0...99999	hysteresis of limit value 2	1
dEL.2	0...99999	alarm 2 delay	0
L3	-19999...99999	lower limit value 3 (L.3 < -19999 \triangleq off)	OFF
H3	-19999...99999	upper limit value 3 (H.3 < -19999 \triangleq off)	OFF
HYS.3	0...99999	hysteresis of limit value 3	1
dEL.3	0...99999	alarm 3 delay	0



Resetting the controller configuration to factory setting (Default)

→ chapter 11.1 (page 47)

6.3 Input scaling

When using current or voltage signals as input variables for *INP.1* or *INP.2*, scaling of input and display values at parameter setting level is required. Specification of the input value for lower and higher scaling point is in the relevant electrical unit (mA / V).

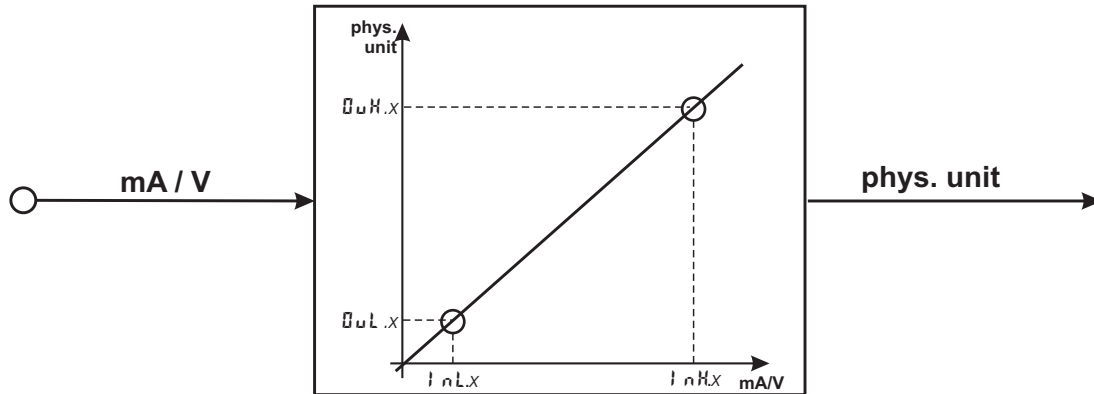

6.3.1 Input *INP*

i Parameters *INL.1*, *OU L.1*, *INH.1* and *OU H.1* are only visible if *CONF / INP.1 / CORR = 3* is chosen.

The parameters *INL* and *INH* determine the input range

Example mA:

INL = 4 and *INH* = 20 means, the measurement is from 4 to 20 mA.



For using the predetermined scaling with thermocouple and resistance thermometer (Pt100), the settings for *INL.1* and *OU L.1* and for *INH.1* and *OU H.1* must have the same value.

7 Calibration level

i Measured value correction (ϵ_{RL}) is only visible if $\epsilon_{conf} / \epsilon_{npl} / \epsilon_{corr} = 1$ or 2 is chosen.

The measured value can be matched in the calibration menu (ϵ_{RL}). Two methods are available:

7.1 Offset correction

($\epsilon_{conf} / \epsilon_{npl} / \epsilon_{corr} = 1$):

possible on-line at the process

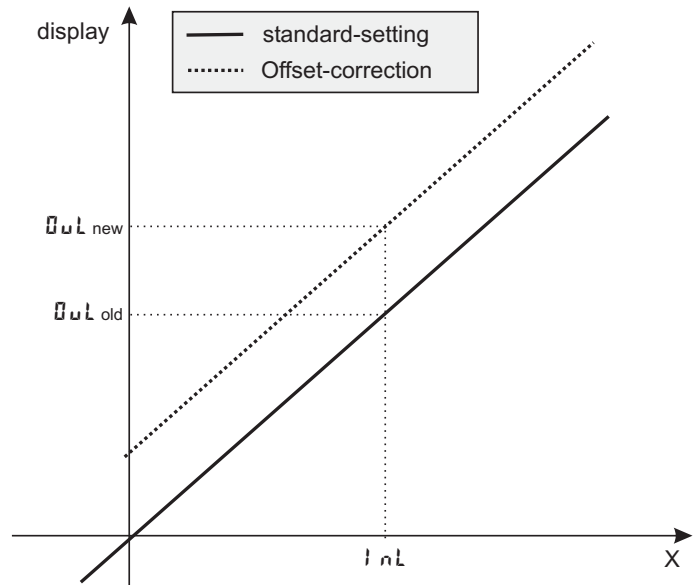

2-point correction



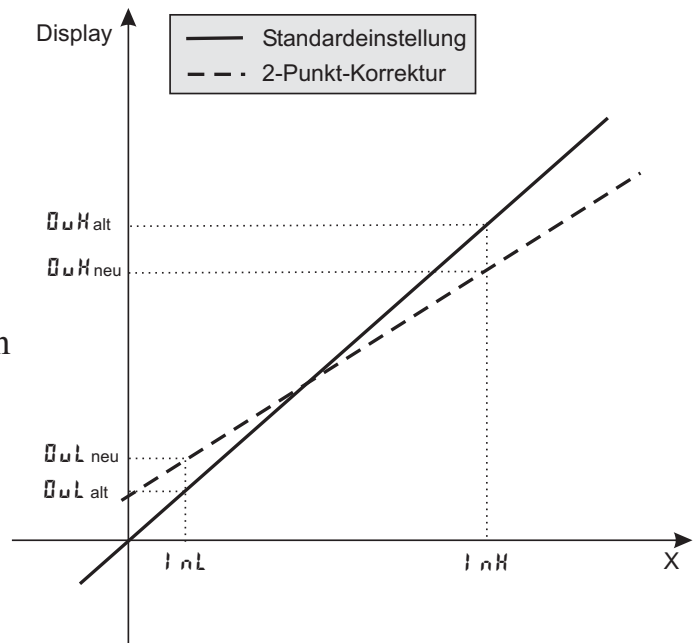

($\epsilon_{conf} / \epsilon_{npl} / \epsilon_{corr} = 2$):

- is possible off-line with process value simulator
- online in 2 Schritten zunächst den einen Wert korrigieren und später, z.B. nach dem Aufheizen des Ofens, den zweiten Wert korrigieren.

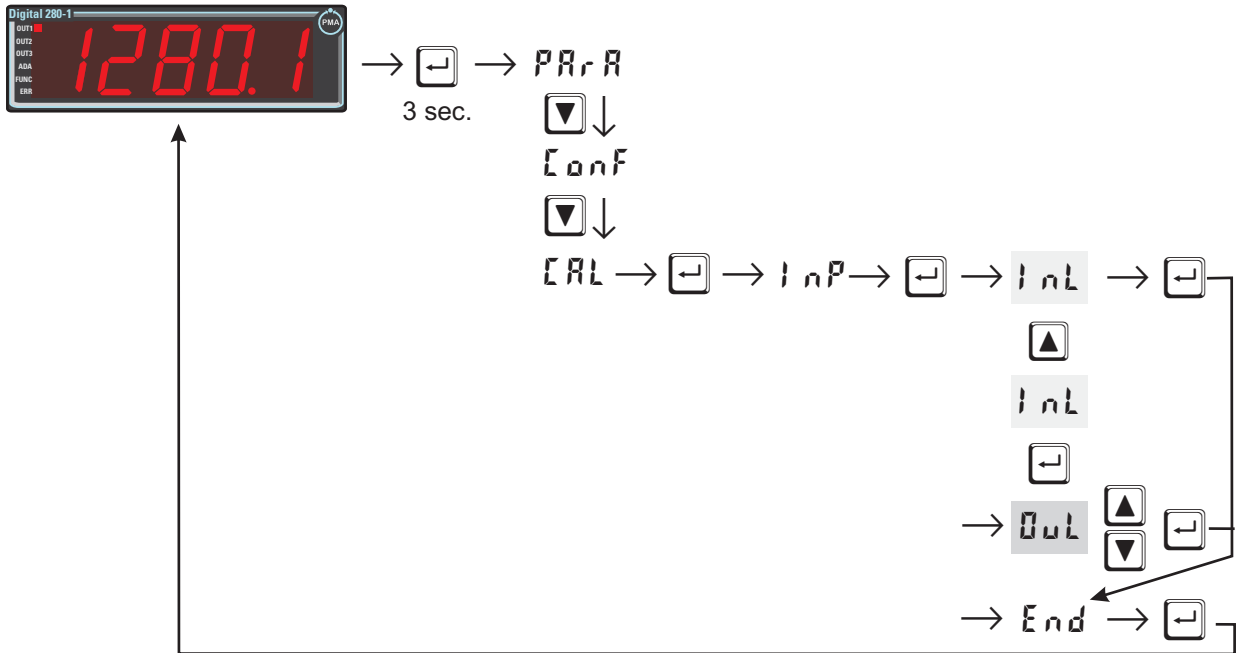







Offset correction ($CONF/INP.I/CONF = 1$):

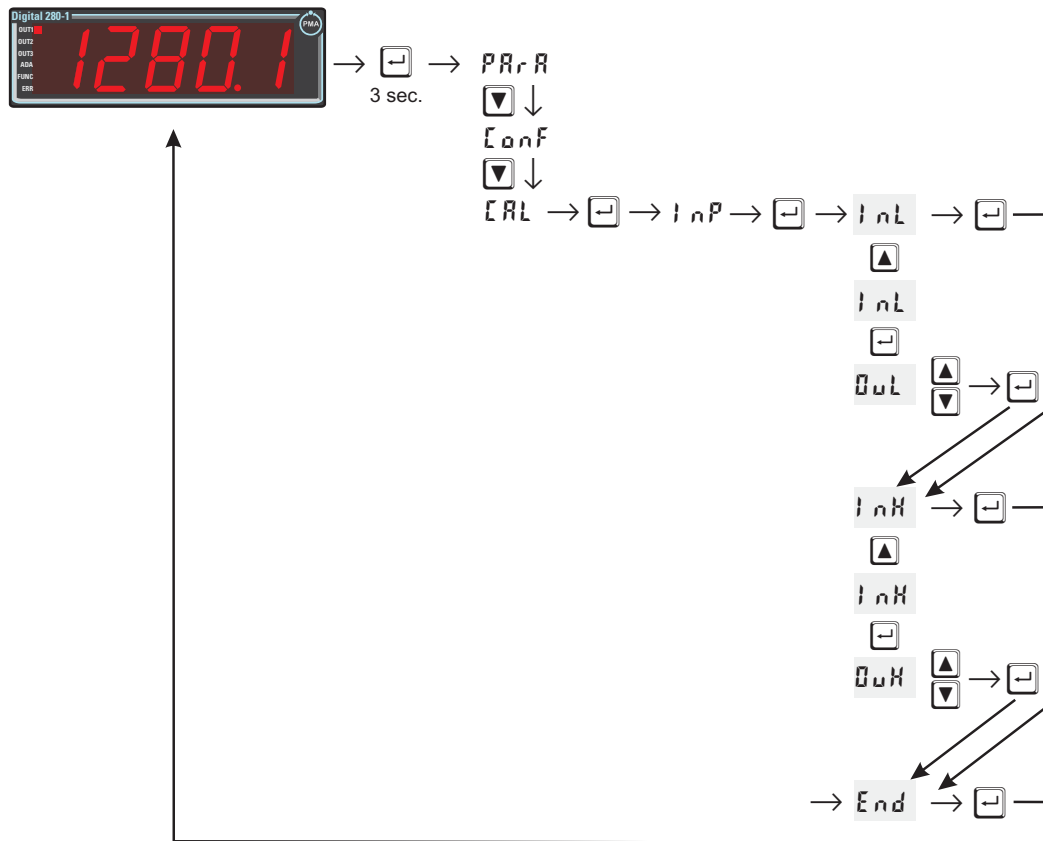

- INL.I:** The input value of the scaling point is displayed.
The operator must wait, until the process is at rest.
Subsequently, the operator acknowledges the input value by pressing key .
- OUT.I:** The display value of the scaling point is displayed.
Before calibration, **OUT.I** is equal to **INL.I**.
The operator can correct the display value by pressing keys .
Subsequently, he confirms the display value by pressing key .

2-point correction ($CoF / InP.1 / Corr = 1$):



- InL.1:** The input value of the lower scaling point is displayed.
The operator must adjust the lower input value by means of a process value simulator and confirm the input value by pressing key .
- OutL.1:** The display value of the lower scaling point is displayed.
Before calibration, **OutL.1** equals **InL.1**.
The operator can correct the lower display value by pressing the   keys. Subsequently, he confirms the display value by pressing key .
- InH.1:** The input value of the upper scaling point is displayed. .
The operator must adjust the upper input value by means of the process value simulator and confirm the input value by pressing key .
- OutH.1:** The display value of the upper scaling point is displayed.
Before calibration **OutH.1** equals **InH.1**.

8 BlueControl

BlueControl is the projection environment for the BluePort® controller series of PMA. The following 3 versions with graded functionality are available:

Functionality	Mini	Basic	Expert
parameter and configuration setting	yes	yes	yes
controller and control loop simulation	yes	yes	yes
download: writes an engineering to the controller	yes	yes	yes
online mode/ visualisation	SIM only	yes	yes
creation of user defined linearizations	yes	yes	yes
configuration of extended operating level	yes	yes	yes
upload: reads an engineering from the controller	SIM only	yes	yes
diagnosis function	no	no	yes
file, save engineering data	no	yes	yes
printer function	no	yes	yes
online documentation, help system	no	yes	yes
measurement correction (calibration procedure)	no	yes	yes
program editor	no	no	yes
data acquisition and trend function	SIM only	yes	yes
network and multiuser licence	no	no	yes
personal assistant function	yes	yes	yes
extended simulation	no	no	yes
extended diagnose and service	no	no	yes

The mini version is - free of charge - at your disposal as download at PMA homepage www.pma-online.de or on the PMA-CD (please ask for).

At the end of the installation the licence number has to be stated or DEMO mode must be chosen. At DEMO mode the licence number can be stated subsequently under **Help** → **Licence** → **Change**.

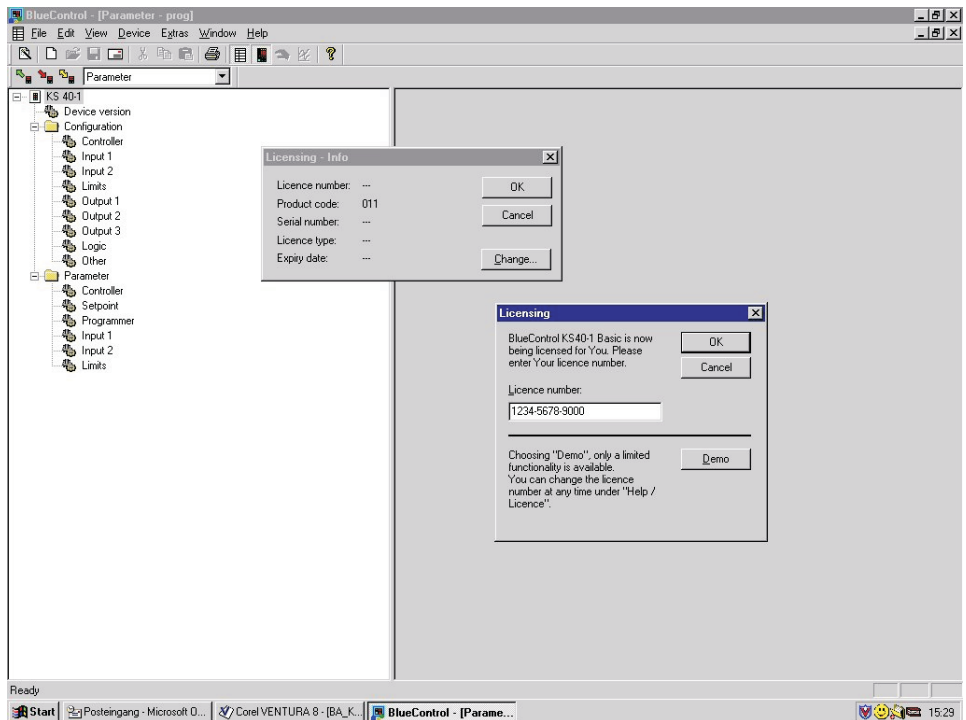

9 Versions

Digital 280-1	D	2	8	0	-	1	-	0	0	-	0	0
Connection via screw-terminal						1						
90..250V AC						0						
24VAC / 18..30VDC						1						
90..250V AC, 2 relay+ mA/V/logic						2						
24VAC / 18..30VDC, 2 relay+ mA/V/logic						3						
No option						0						
Modbus RTU + transmitter supply						1						
Digital inputs di2, di3 (optocoupler)												
Standard configuration									0			
Configuration to specification									9			
no operation manual										0		
operation manual german										D		
operation manual english										E		
operation manual french										F		
Standard (CE - certified)											0	
UL-certified											U	

Accessories delivered with the unit

Operating manual (if selected by the ordering code)

- 2 fixing clamps

Accessory equipment with ordering information

Description			Order no.
Heating current transformer 50A AC			9404-407-50001
PC-adaptor for the front-panel interface			9407-998-00001
Standard rail adaptor			9407-998-00061
Operating manual	German		9499-040-62718
Operating manual	English		9499-040-62711
Operating manual	French		9499-040-62732
Interface description Modbus RTU	German		9499-040-63518
Interface description Modbus RTU	English		9499-040-63511
BlueControl (engineering tool)	Mini	Download	www.pma-online.de
BlueControl (engineering tool)	Basic		9407-999-11001
BlueControl (engineering tool)	Expert		9407-999-11011

10 Technical data

INPUTS

PROCESS VALUE INPUT INP1

Resolution:	> 15 bits
Decimal point:	0 to 4 digits behind the decimal point
Limiting frequency:	2 Hz (analog)
Dig. input filter:	adjustable 0,1...100 s
Scanning cycle:	100 ms
Measured value correction:	2-point or offset correction

Thermocouple → Table 1

Input resistance:	± 1 MW
Source resistance effect:	1 µV/Ω

Temperature compensation

Internal temperature compensation

Maximum additional error ± 0,5 K

External temperature compensation

between 0 and 100 °C or adjustable 32 und 212 °F

Break monitoring

Sensor current: £ 1 mA

Resistance thermometer → Table 2

Connection technique:	3-wire
Lead resistance:	max. 30 Ohm
Input circuit monitoring:	break and short circuit

Resistance measuring range

The BlueControl software can be used for adaptation of the characteristic stored for temperature sensor KTY 11-6.

Physical measuring range: 0...450 Ohm
0...4500 Ohm

Number of linearization segments 15

Current and voltage measuring ranges → Table 3

Span start, span end:	anywhere within the measuring range
Scaling:	selectable -19999...99999
Linearization:	15 segments, adaptable via BlueControl
Decimal point:	adjustable
Input circuit monitoring:	with 4..20mA and 2..10V: 12,5% below span start (2mA, 1V)

CONTROL INPUT DI1

Configurable as switch or push-button!
Connection of a potential-free contact suitable for switching "dry" circuits.

Switched voltage:	2,5 V
Current:	50 mA

CONTROL INPUTS DI2, DI3 (OPTION)

Configurable as switch or push-button!
Optocoupler input for active triggering

Nominal voltage	24 V DC external
Current sink (IEC 1131 type 1)	
Logic "0"	-3...5 V
Logic "1"	15...30 V
Current requirement	approx.. 5 mA

Transmitter supply U_T (Option)

Power: 22 mA / ± 18 V

If the universal output OUT3 is used there may be no external galvanic connection between measuring and output circuits!

FILTER

A first order mathematic filter which is adjustable for time constant and bandwidth is built in.

The bandwidth is the adjustable tolerance around the process value within which the filter is active. Measured value changes exceeding the adjusted bandwidth are output directly.

OUTPUTS

Survey of outputs

Output	Used as
OUT1 (relay) OUT2 (relay) OUT3 (logic)	Limit contacts, alarms, control output
OUT3 (continuous)	Control output, process value, set-point, control deviation, 13V/22mA transmitter power supply

* All logic signals can be combined in an OR function!

RELAY OUTPUTS OUT1, OUT2

Contact type:	2 NO contacts with common connection
Max. contact rating:	500 VA, 250 V, 2A at 48..62 Hz, resistive load
Min. contact rating:	6V, 1 mA DC
Operating life (electr.):	800.000 duty cycles with max. rating

Note:

If the relays OUT1...OUT3 operate external contactors, these must be fitted with RC snubber circuits to manufacturer specifications to prevent excessive switch-off voltage peaks..

OUT3 AS UNIVERSAL OUTPUT

Galvanically isolated from the inputs.

Freely scalable	
Resolution:	11 Bit
Timeconstant of DA-transducer T90	50 ms
Limitfrequency of the whole continuous controller	> 2 Hz

Current output

0/4...20 mA configurable.

Signal range:	0...ca.21,5 mA
Max. load:	≤ 500 Ω
Load effect:	0,02 % / 100 Ω
Resolution:	≤ 22 μA (0,1%)
Accuracy	≤ 40 μA (0,2%)

Voltage output (short-circuit proof)

0/2...10V configurable

Signal range:	0...ca.11 V
Min. load:	≥ 2 kΩ
Load effect:	kein Einfluß
Resolution:	≤ 11 mV (0,1%)
Accuracy	≤ 20 mV (0,2%)

OUT3 used as transmitter supply

Output power: 22 mA / ≥ 13 V

OUT3 used as logic output

Load ≤ 500 Ω	0/≤ 20 mA
Load > 500 Ω	0/> 13 V

FUNCTIONS

Control behaviour

- Signaller with adjustable switching difference (ON/OFF controller)
- PID controller (2-point and continuous)

Control parameters self-adjusting or manually adjustable via front panel keys or BlueControl software.

Limit value functions

Monitoring is provided for: exceeded max., min. or max. and min. limit value with adjustable hysteresis.

The following signals can be monitored:

- Measured value
- Process value
- Control deviation
- Control deviation with suppression after start-up or set-point changes
- Set-point
- Correcting variable Y

Functions

- Measured value monitoring
- Measured value monitoring with storage. Reset via front panel keys or digital input

- Measured value change
- Measured value change and storage

Several limit values and alarms can be combined by a logic OR function and output e.g. as a common alarm.

ALARM + MAINTENANCE MANAGER

Display of error messages, warnings and stored limit signalings in the error list.

Messages are stored and can be reset manually.

Possible elements of the error list:

- Sensor break, short circuit, polarity error
- Self-tuning error
- Stored limit values
 - E.g. recalibration warning (when exceeding an adjustable number of operating hours, a message is displayed)
 - E.g. maintenance interval of switching element (when exceeding an adjustable number of switching cycles, a message is displayed)
- Internal errors (RAM, EEPROM, ...)

DISPLAY

Display

5-digit 19 mm LED

POWER SUPPLY

Dependent of order:

AC SUPPLY

Voltage:	90...250 V AC
Frequency:	48...62 Hz
Power consumption	approx. 7.3 VA

UNIVERSAL SUPPLY 24 V UC

AC voltage:	20,4...26,4 V AC
Frequency:	48...62 Hz
DC voltage:	18...31 V DC
Power consumption:	approx.. 7.3 VA

BEHAVIOUR WITH POWER FAILURE

Configuration, parameters and adjusted set-points, control mode:

Non-volatile storage in EEPROM

BLUEPORT FRONT INTERFACE

Connection of PC via PC adapter (see "Accessory equipment"). The BlueControl software is used to configure, set parameters and operate the KS4x-1.

BUS INTERFACE (OPTION)

Galvanically isolated	
Physical:	RS 422/485

Protocol: Modbus RTU
 Transmission speed: 2400, 4800, 9600, 19.200 bits/sec
 Address range: 1...247
 Number of controllers per bus: 32
 Repeaters must be used to connect a higher number of controllers.

ENVIRONMENTAL CONDITIONS

Protection modes

Front panel: IP 65
 Housing: IP 20
 Terminals: IP 00

Permissible temperatures

For specified accuracy: 0...60°C
 Warm-up time: ≥ 15 minutes
 For operation: -20...65°C
 For storage: -40...70°C

Humidity

75% yearly average, no condensation

Shock and vibration

Vibration test Fc (DIN 68-2-6)

Frequency: 10...150 Hz
 Unit in operation: 1g or 0,075 mm
 Unit not in operation: 2g or 0,15 mm

Shock test Ea (DIN IEC 68-2-27)

Shock: 15g
 Duration: 11ms

Electromagnetic compatibility

Complies with EN 61 326-1
 (for continuous, non-attended operation)

ALLGEMEINES

Housing

Material: Makrolon 9415 flame-retardant
 Flammability class: UL 94 VO, self-extinguishing

Plug-in module, inserted from the front

Safety test

Complies with EN 61010-1 (VDE 0411-1):
 Overvoltage category II
 Contamination class 2
 Working voltage range 300 V
 Protection class II

cUL certification

(Type 1, indoor use)
 File: E 208286

Electrical connections

Screw terminals for 0,5 to 2,5 mm²

Mounting

Panel mounting with two fixing clamps at top/bottom or right/left,
 High-density mounting possible

Mounting position: uncritical
 Weight: 0,27kg

Accessories delivered with the unit

Operating manual
 Fixing clamps

Table 1 thermocouple measuring range

thermocouple type		measuring range		accuracy	resolution (∅)
L	Fe-CuNi (DIN)	-100...900°C	-148...1652°F	≤ 2 K	0,05 K
J	Fe-CuNi	-100...1200°C	-148...2192°F	≤ 2 K	0,05 K
K	NiCr-Ni	-100...1350°C	-148...2462°F	≤ 2 K	0,1 K
N	Nicrosil/Nisil	-100...1300°C	-148...2372°F	≤ 2 K	0,1 K
S	PtRh-Pt 10%	0...1760°C	32...3200°F	≤ 2 K	0,1 K
R	PtRh-Pt 13%	0...1760°C	32...3200°F	≤ 2 K	0,1 K
T	Cu-CuNi	-200...400°C	-328...752°F	≤ 2 K	0,025 K
C	W5%Re-W26%Re	0...2315°C	32...4199°F	≤ 2 K	0,2 K
D	W3%Re-W25%Re	0...2315°C	32...4199°F	≤ 2 K	0,2 K
E	NiCr-CuNi	-100...1000°C	-148...1832°F	≤ 2 K	0,05 K
B ⁽¹⁾	PtRh-Pt6%	0(100)...1820°C	32(212)...3308°F	≤ 3 K	0,15 K
special		-25...75 mV		≤ 0,1 %	0,005 %

⁽¹⁾ Values for type B are valid from 100°C.

Table 2 Resistance transducer measuring ranges

Type	Meas.curr.	Measuring range		Accuracy	Resolution (∅)
Pt100	0,2 mA	-200...850°C	-328...1562°F	≤ 1 K	0,05 K
Pt1000		-200...850°C	-328...1562°F	≤ 2 K	
Special*		0...4500 Ω**		≤ 0,1 %	0,005 %
Special		0...450 Ω**			
Pot.		0...160 Ω**			
Pot.	0...450 Ω**				
Pot.	0...1600 Ω**				

* Characteristic KTY 11-6 (-50...150°C) is factory-set.

** inclusive of lead resistance

Table 3 Current and voltage measuring ranges

Measuring range	Input resistance	Accuracy	Resolution (∅)
0...20 mA	49 Ω (voltage requirement ≤ 2,5 V)	≤ 0,1 %	0,75 μA
0...10 Volt	≈ 110 kΩ	≤ 0,1 %	0,4 mV
-2,5...115 mV*	≥ 1MΩ	≤ 0,1 %	4 μV
-25...1150 mV*	≥ 1MΩ	≤ 0,1 %	40 μV
-25...90 mV*	≥ 1MΩ	≤ 0,1 %	4μV
-500...500 mV*	≥ 1MΩ	≤ 0,1 %	40 μV
-5...5Volt	≈ 110 kΩ	≤ 0,1 %	0,4 mV

* high-impedance voltage ranges without break monitoring

11 Safety hints

This unit was built and tested in compliance with VDE 0411-1 / EN 61010-1 and was delivered in safe condition.

The unit complies with European guideline 89/336/EEG (EMC) and is provided with CE marking.

The unit was tested before delivery and has passed the tests required by the test schedule. To maintain this condition and to ensure safe operation, the user must follow the hints and warnings given in this operating manual.

The unit is intended exclusively for use as a measurement and control instrument in technical installations.



Warning

If the unit is damaged to an extent that safe operation seems impossible, the unit must not be taken into operation.

ELECTRICAL CONNECTIONS

The electrical wiring must conform to local standards (e.g. VDE 0100). The input measurement and control leads must be kept separate from signal and power supply leads.

In the installation of the controller a switch or a circuit-breaker must be used and signified. The switch or circuit-breaker must be installed near by the controller and the user must have easy access to the controller.

COMMISSIONING

Before instrument switch-on, check that the following information is taken into account:

- Ensure that the supply voltage corresponds to the specifications on the type label.
- All covers required for contact protection must be fitted.
- If the controller is connected with other units in the same signal loop, check that the equipment in the output circuit is not affected before switch-on. If necessary, suitable protective measures must be taken.
- The unit may be operated only in installed condition.
- Before and during operation, the temperature restrictions specified for controller operation must be met.

SHUT-DOWN

For taking the unit out of operation, disconnect it from all voltage sources and protect it against accidental operation.

If the controller is connected with other equipment in the same signal loop, check that other equipment in the output circuit is not affected before switch-off. If necessary, suitable protective measures must be taken.

MAINTENANCE, REPAIR AND MODIFICATION

The units do not need particular maintenance.

**Warning**

When opening the units, or when removing covers or components, live parts and terminals may be exposed.

Before starting this work, the unit must be disconnected completely.

After completing this work, re-shut the unit and re-fit all covers and components. Check if specifications on the type label must be changed and correct them, if necessary.

**Caution**

When opening the units, components which are sensitive to electrostatic discharge (ESD) can be exposed. The following work may be done only at workstations with suitable ESD protection.

Modification, maintenance and repair work may be done only by trained and authorized personnel. For this purpose, the PMA service should be contacted.



The cleaning of the front of the controller should be done with a dry or a wetted (spirit, water) kerchief.

11.1 *Resetting to factory setting*

In case of faulty configuration, Digital 280-1 can be reset to the default condition.

For this, keep the following two keys pressed during power-on :



The digital indicator reset to default is signalled by displaying `RESET` shortly in the display. Subsequently, the digital indicator returns to normal operation.

Index	
0-9	
2-point correction.	37
A	
Alarm handling.	15
Anschlußbeispiele	
OUT3 als Logikausgang	8
B	
BlueControl.	40
Bus interface	
Technical Data.	43
C	
Calibration (CAL)	37
Calibration level (CAL)	37 - 39
Configuration examples	
2-point controller	31
Signaller	30
Configuration level	
Parameter survey	23
Configuration-level (CONF)	
Configuration-Parameter	24 - 29
Connecting diagram	6
Connecting examples	
di2/3, 2-wire transmitter supply	7
OUT3 transmitter supply	7
RS485 interface	8
continuous controller.	32
control inputs di1, di2, di3	
Configuration	27
D	
Digital inputs di1, di2, di3	
Technical data	42
E	
Equipment	41
F	
Factory setting	22
Front view	10
Frontansicht	10
I	
Input INP1	
configuration.	24
Parameter setting	35

Input scaling	36
L	
LED	
Ada - LED	10
Err - LED	10
✓ - LED.	10
SP.x - LED.	10
M	
Maintenance manager	16
measured value output	33
Mounting.	5
O	
Offset correction.	37 - 39
operating structure	22
Output OUT1	
Configuration	26
Technical data	42
Output OUT2	
Configuration	26
Technical data	42
Output OUT3	
Configuration	26
P	
Parameter setting level	
Parameter survey	34
Parameter-Level (PARL)	
Parameter	35
R	
Resetting to factory setting.	47
S	
Safety hints	46 - 47
Safety switch.	5
Safety test.	44
Selbstoptimierung	
Start	18
Self-tuning	
Cancelation	18
Start	18
V	
Versions	41

A5 auf A6 gefaltet 2-fach geheftet, SW-Druck, Normalpapier 70g weiß

Subject to alterations without notice
Änderungen vorbehalten
Sous réserve de toutes modifications

© PMA Prozeß- und Maschinen-Automation GmbH
P.O.B. 310 229, D-34058 Kassel, Germany
Printed in Germany 9499-040-67311 (08/2013)

A6